

**DENON** *PROFESSIONAL*

**PROFESSIONAL SOLID STATE PLAYER**

**DN-F300**

---

**OPERATING INSTRUCTIONS**



**CAUTION**  
**RISK OF ELECTRIC SHOCK**  
**DO NOT OPEN**



### **CAUTION:**

**TO REDUCE THE RISK OF ELECTRIC SHOCK, DO NOT REMOVE COVER (OR BACK). NO USER-SERVICEABLE PARTS INSIDE. REFER SERVICING TO QUALIFIED SERVICE PERSONNEL.**



The lightning flash with arrowhead symbol, within an equilateral triangle, is intended to alert the user to the presence of uninsulated "dangerous voltage" within the product's enclosure that may be of sufficient magnitude to constitute a risk of electric shock to persons.



The exclamation point within an equilateral triangle is intended to alert the user to the presence of important operating and maintenance (servicing) instructions in the literature accompanying the appliance.

## **FCC INFORMATION** **(For US customers)**

### **1. COMPLIANCE INFORMATION**

**Product Name: Solid state player**

**Model Number: DN-F300**

This product complies with Part 15 of the FCC Rules. Operation is subject to the following two conditions: (1) this product may not cause harmful interference, and (2) this product must accept any interference received, including interference that may cause undesired operation.

Denon Professional div. D&M Professional  
1100 Maplewood Drive Itasca, IL 60143  
Tel. 630-741-0330

### **2. IMPORTANT NOTICE: DO NOT MODIFY THIS PRODUCT**

This product, when installed as indicated in the instructions contained in this manual, meets FCC requirements. Modification not expressly approved by DENON may void your authority, granted by the FCC, to use the product.

### **3. NOTE**

This product has been tested and found to comply with the limits for a Class B digital device, pursuant to Part 15 of the FCC Rules. These limits are designed to provide reasonable protection against harmful interference in a residential installation.

This product generates, uses and can radiate radio frequency energy and, if not installed and used in accordance with the instructions, may cause harmful interference to radio communications. However, there is no guarantee that interference will not occur in a particular installation. If this product does cause harmful interference to radio or television reception, which can be determined by turning the product OFF and ON, the user is encouraged to try to correct the interference by one or more of the following measures:

- Reorient or relocate the receiving antenna.
- Increase the separation between the equipment and receiver.
- Connect the product into an outlet on a circuit different from that to which the receiver is connected.
- Consult the local retailer authorized to distribute this type of product or an experienced radio/TV technician for help.

This Class B apparatus complies with Canadian ICES-003.

Cet appareil numérique de la classe B est conforme à la norme NMB-003 du Canada.

# IMPORTANT SAFETY INSTRUCTIONS

1. Read these instructions.
2. Keep these instructions.
3. Heed all warnings.
4. Follow all instructions.
5. Do not use this apparatus near water.
6. Clean only with dry cloth.
7. Do not block any ventilation openings.

Install in accordance with the manufacturer's instructions.

8. Do not install near any heat sources such as radiators, heat registers, stoves, or other apparatus (including amplifiers) that produce heat.
9. Protect the power cord from being walked on or pinched particularly at plugs, convenience receptacles, and the point where they exit from the apparatus.
10. Only use attachments/accessories specified by the manufacturer.
11. Use only with the cart, stand, tripod, bracket, or table specified by the manufacturer, or sold with the apparatus. When a cart is used, use caution when moving the cart/apparatus combination to avoid injury from tip-over.
12. Unplug this apparatus during lightning storms or when unused for long periods of time.
13. Refer all servicing to qualified service personnel. Servicing is required when the apparatus has been damaged in any way, such as power-supply cord or plug is damaged, liquid has been spilled or objects have fallen into the apparatus, the apparatus has been exposed to rain or moisture, does not operate normally, or has been dropped.
14. Batteries shall not be exposed to excessive heat such as sunshine, fire or the like.



## CAUTION:

*(English)*

To completely disconnect this product from the mains, disconnect the plug from the wall socket outlet.

The mains plug is used to completely interrupt the power supply to the unit and must be within easy access by the user.

Do not expose batteries to excessive heat such as sunshine, fire or the like.

## VORSICHT:

*(Deutsch)*

Um dieses Gerät vollständig von der Stromversorgung abzutrennen, trennen Sie bitte den Netzstecker von der Wandsteckdose ab.

Die Hauptstecker werden verwendet, um die Stromversorgung zum Gerät völlig zu unterbrechen; er muss für den Benutzer gut und einfach zu erreichen sein.

Setzen Sie Batterien nicht übermäßiger Wärme aus, z. B. Sonnenstrahlung, Feuer oder dergleichen.

## PRECAUTION:

*(Français)*

Pour déconnecter complètement ce produit du courant secteur, débranchez la prise de la prise murale.

La prise secteur est utilisée pour couper complètement l'alimentation de l'appareil et l'utilisateur doit pouvoir y accéder facilement.

N'exposez pas les batteries à une chaleur excessive telle que le soleil, le feu ou autre.

## ATTENZIONE:

*(Italiano)*

Per scollegare definitivamente questo prodotto dalla rete di alimentazione elettrica, togliere la spina dalla relativa presa.

La spina di rete viene utilizzata per interrompere completamente l'alimentazione all'unità e deve essere facilmente accessibile all'utente.

Non esporre le batterie a un calore eccessivo, per esempio al sole, al fuoco o altre fonti.

## PRECAUCIÓN:

*(Español)*

Para desconectar completamente este producto de la alimentación eléctrica, desconecte el enchufe del enchufe de la pared.

El enchufe de la alimentación se utiliza para interrumpir por completo el suministro de alimentación a la unidad y debe de encontrarse en un lugar al que el usuario tenga fácil acceso.

No exponga las pilas a calor excesivo, como a la luz solar, el fuego, etc.

## VOORZICHTIGHEID:

*(Nederlands)*

Om de voeding van dit product volledig te onderbreken moet de stekker uit het stopcontact worden getrokken.

De netstekker wordt gebruikt om de stroomtoevoer naar het toestel volledig te onderbreken en moet voor de gebruiker gemakkelijk bereikbaar zijn.

Stel de batterijen niet bloot aan felle zonneschijn, brand, enzovoorts.

## FÖRSIKTIHETSMÅTT:

*(Svenska)*

Koppla loss stickproppen från eluttaget för att helt skilja produkten från nätet.

Stickproppen används för att helt bryta strömförsörjningen till apparaten, och den måste vara lättillgänglig för användaren.

Utsätt inte batterierna för stark hetta såsom solsken, eld eller liknande.

## ATENÇÃO:

*(Português)*

Para desligar completamente este produto da corrente, desligue a ficha da tomada elétrica.

A ficha elétrica é utilizada para interromper completamente a alimentação da unidade e deve estar num local onde o utilizador lhe possa aceder facilmente.

Não exponha as pilhas a fontes de calor excessivo, como luz solar, fogo ou semelhantes.

## NOTE ON USE

- Avoid high temperatures.  
Allow for sufficient heat dispersion when installed in a rack.
- Handle the power cord carefully.  
Hold the plug when unplugging the cord.
- Keep the unit free from moisture, water, and dust.
- Unplug the power cord when not using the unit for long periods of time.
- Do not obstruct the ventilation holes.
- Do not let foreign objects into the unit.
- Do not let insecticides, benzene, and thinner come in contact with the unit.
- Never disassemble or modify the unit in any way.

## HINWEISE ZUM GEBRAUCH

- Vermeiden Sie hohe Temperaturen.  
Beachten Sie, dass eine ausreichende Belüftung gewährleistet wird, wenn das Gerät auf ein Regal gestellt wird.
- Gehen Sie vorsichtig mit dem Netzkabel um.  
Halten Sie das Kabel am Stecker, wenn Sie den Stecker herausziehen.
- Halten Sie das Gerät von Feuchtigkeit, Wasser und Staub fern.
- Wenn das Gerät längere Zeit nicht verwendet werden soll, trennen Sie das Netzkabel vom Netzstecker.
- Decken Sie den Lüftungsbereich nicht ab.
- Lassen Sie keine fremden Gegenstände in das Gerät kommen.
- Lassen Sie das Gerät nicht mit Insektiziden, Benzin oder Verdünnungsmitteln in Berührung kommen.
- Versuchen Sie niemals das Gerät auseinander zu nehmen oder zu verändern.

## OBSERVATIONS RELATIVES A L'UTILISATION

- Eviter des températures élevées.  
Tenir compte d'une dispersion de chaleur suffisante lors de l'installation sur une étagère.
- Manipuler le cordon d'alimentation avec précaution.  
Tenir la prise lors du débranchement du cordon.
- Protéger l'appareil contre l'humidité, l'eau et la poussière.
- Débrancher le cordon d'alimentation lorsque l'appareil n'est pas utilisé pendant de longues périodes.
- Ne pas obstruer les trous d'aération.
- Ne pas laisser des objets étrangers dans l'appareil.
- Ne pas mettre en contact des insecticides, du benzène et un diluant avec l'appareil.
- Ne jamais démonter ou modifier l'appareil d'une manière ou d'une autre.

## NOTE SULL'USO

- Evitate di esporre l'unità a temperature elevate.  
Assicuratevi che vi sia un'adeguata dispersione del calore quando installate l'unità in un mobile per componenti audio.
- Manneggiate il cavo di alimentazione con attenzione.  
Tenete ferma la spina quando scollegate il cavo dalla presa.
- Tenete l'unità lontana dall'umidità, dall'acqua e dalla polvere.
- Scollegate il cavo di alimentazione quando prevedete di non utilizzare l'unità per un lungo periodo di tempo.
- Non coprite i fori di ventilazione.
- Non inserite corpi estranei all'interno dell'unità.
- Assicuratevi che l'unità non entri in contatto con insetticidi, benzolo o solventi.
- Non smontate né modificate l'unità in alcun modo.

(English)

## NOTAS SOBRE EL USO

- Evite altas temperaturas.  
Permite la suficiente dispersión del calor cuando está instalado en la consola.
- Maneje el cordón de energía con cuidado.  
Sostenga el enchufe cuando desconecte el cordón de energía.
- Mantenga el equipo libre de humedad, agua y polvo.
- Desconecte el cordón de energía cuando no utilice el equipo por mucho tiempo.
- No obstruya los orificios de ventilación.
- No deje objetos extraños dentro del equipo.
- No permita el contacto de insecticidas, gasolina y diluyentes con el equipo.
- Nunca desarme o modifique el equipo de ninguna manera.

## ALVORENS TE GEBRUIKEN

- Vermijd hoge temperaturen.  
Zorg er bij installatie in een audiorack voor, dat de door het toestel geproduceerde warmte goed kan worden afgevoerd.
- Hanteer het netsnoer voorzichtig.  
Houd het snoer bij de stekker vast wanneer deze moet worden aan- of losgekoppeld.
- Laat geen vochtigheid, water of stof in het apparaat binnendringen.
- Neem altijd het netsnoer uit het stopcontact wanneer het apparaat gedurende een lange periode niet wordt gebruikt.
- De ventilatieopeningen mogen niet worden geblokkeerd.
- Laat geen vreemde voorwerpen in dit apparaat vallen.
- Voorkom dat insecticiden, benzeen of verfverdunder met dit toestel in contact komen.
- Dit toestel mag niet gedemonteerd of aangepast worden.

## OBSERVERA ANGÅENDE ANVÄNDNINGEN

- Undvik höga temperaturer.  
Se till att det finns möjlighet till god värmeavledning vid montering i ett rack.
- Hantera nätkabeln varsamt.  
Håll i kabeln när den kopplas från el-uttaget.
- Utsätt inte apparaten för fukt, vatten och damm.
- Koppla loss nätkabeln om apparaten inte kommer att användas i lång tid.
- Täpp inte till ventilationsöppningarna.
- Se till att främmande föremål inte tränger in i apparaten.
- Se till att inte insektsmedel på spraybruk, bensen och thinner kommer i kontakt med apparatens hölje.
- Ta inte isär apparaten och försök inte bygga om den.

(Deutsch)

(Español)

(Nederlands)

(Français)

(Svenska)

(Italiano)

**CAUTION:****(English)**

- The ventilation should not be impeded by covering the ventilation openings with items, such as newspapers, tablecloths, curtains, etc.
- No naked flame sources, such as lighted candles, should be placed on the unit.
- Observe and follow local regulations regarding battery disposal.
- Do not expose the unit to dripping or splashing fluids.
- Do not place objects filled with liquids, such as vases, on the unit.

**ACHTUNG:****(Deutsch)**

- Die Belüftung sollte auf keinen Fall durch das Abdecken der Belüftungsöffnungen durch Gegenstände wie beispielsweise Zeitungen, Tischtücher, Vorhänge o. Ä. behindert werden.
- Auf dem Gerät sollten keinerlei direkte Feuerquellen wie beispielsweise angezündete Kerzen aufgestellt werden.
- Bitte beachten Sie bei der Entsorgung der Batterien die örtlich geltenden Umweltbestimmungen.
- Das Gerät sollte keiner tropfenden oder spritzenden Flüssigkeit ausgesetzt werden.
- Auf dem Gerät sollten keine mit Flüssigkeit gefüllten Behälter wie beispielsweise Vasen aufgestellt werden.

**ATTENTION:****(Français)**

- La ventilation ne doit pas être gênée en recouvrant les ouvertures de la ventilation avec des objets tels que journaux, rideaux, tissus, etc.
- Aucune flamme nue, par exemple une bougie, ne doit être placée sur l'appareil.
- Veillez à respecter les lois en vigueur lorsque vous jetez les piles usagées.
- L'appareil ne doit pas être exposé à l'eau ou à l'humidité.
- Ne pas poser d'objet contenant du liquide, par exemple un vase, sur l'appareil.

**ATTENZIONE:****(Italiano)**

- Le aperture di ventilazione non devono essere ostruite coprendole con oggetti, quali giornali, tovaglie, tende e così via.
- Non posizionate sull'unità fiamme libere, come ad esempio candele accese.
- Prestate attenzione agli aspetti legati alla tutela dell'ambiente nello smaltimento delle batterie.
- L'apparecchiatura non deve essere esposta a gocciolii o spruzzi.
- Non posizionate sull'unità alcun oggetto contenente liquidi, come ad esempio i vasi.

**PRECAUCIÓN:****(Español)**

- La ventilación no debe quedar obstruida por haberse cubierto las aperturas con objetos como periódicos, manteles, cortinas, etc.
- No debe colocarse sobre el aparato ninguna fuente inflamable sin protección, como velas encendidas.
- A la hora de deshacerse de las pilas, respete la normativa para el cuidado del medio ambiente.
- No exponer el aparato al goteo o salpicaduras cuando se utilice.
- No colocar sobre el aparato objetos llenos de líquido, como jarros.

**WAARSCHUWING:****(Nederlands)**

- De ventilatie mag niet worden belemmerd door de ventilatieopeningen af te dekken met bijvoorbeeld kranten, een tafelkleed, gordijnen, enz.
- Plaats geen open vlammen, bijvoorbeeld een brandende kaars, op het apparaat.
- Houd u steeds aan de milieuvoorschriften wanneer u gebruikte batterijen wegdoet.
- Stel het apparaat niet bloot aan druppels of spatten.
- Plaats geen voorwerpen gevuld met water, bijvoorbeeld een vaas, op het apparaat.

**OBSERVERA:****(Svenska)**

- Ventilationen bör inte förhindras genom att täcka för ventilationsöppningarna med föremål såsom tidningar, bordsdukar, gardiner osv.
- Inga blottade brandkällor, såsom tända ljus, får placeras på apparaten.
- Tänk på miljöaspekterna när du bortskaffar batterier.
- Apparaten får inte utsättas för vätska.
- Placera inte föremål fyllda med vätska, t.ex. vaser, på apparaten.

**•DECLARATION OF CONFORMITY****(English)**

We declare under our sole responsibility that this product, to which this declaration relates, is in conformity with the following standards:  
EN60065, EN55013, EN55020, EN61000-3-2 and EN61000-3-3.  
Following the provisions of 2006/95/EC and 2004/108/EC Directive.

**•ÜBEREINSTIMMUNGSERKLÄRUNG****(Deutsch)**

Wir erklären unter unserer Verantwortung, daß dieses Produkt, auf das sich diese Erklärung bezieht, den folgenden Standards entspricht:  
EN60065, EN55013, EN55020, EN61000-3-2 und EN61000-3-3.  
Entspricht den Bestimmungen der Richtlinien 2006/95/EG und 2004/108/EG.

**•DECLARATION DE CONFORMITE****(Français)**

Nous déclarons sous notre seule responsabilité que l'appareil, auquel se réfère cette déclaration, est conforme aux standards suivants:  
EN60065, EN55013, EN55020, EN61000-3-2 et EN61000-3-3.  
Conforme aux dispositions des directives 2006/95/EC et 2004/108/EC.

**•DICHIARAZIONE DI CONFORMITÀ****(Italiano)**

Dichiariamo con piena responsabilità che questo prodotto, al quale la nostra dichiarazione si riferisce, è conforme alle seguenti normative:  
EN60065, EN55013, EN55020, EN61000-3-2 e EN61000-3-3.  
Conforme alle norme delle direttive 2006/95/EC e 2004/108/EC.  
QUESTO PRODOTTO E' CONFORME  
AL D.M. 28/08/95 N. 548

**•DECLARACIÓN DE CONFORMIDAD****(Español)**

Declaramos bajo nuestra exclusiva responsabilidad que este producto al que hace referencia esta declaración, está conforme con los siguientes estándares:  
EN60065, EN55013, EN55020, EN61000-3-2 y EN61000-3-3.  
Siguiendo las disposiciones de las Directivas 2006/95/CE y 2004/108/CE.

**•EENVORMIGHEIDSVERKLARING****(Nederlands)**

Wij verklaren uitsluitend op onze verantwoordelijkheid dat dit produkt, waarop deze verklaring betrekking heeft, in overeenstemming is met de volgende normen:  
EN60065, EN55013, EN55020, EN61000-3-2 en EN61000-3-3.  
Voldoet aan de bepalingen van de EC-richtlijnen 2006/95/EC en 2004/108/EC.

**•ÖVERENSSTÄMMELSESINTYG****(Svenska)**

Härmed intygas helt på eget ansvar att denna produkt, vilken detta intyg avser, uppfyller följande standarder:  
EN60065, EN55013, EN55020, EN61000-3-2 och EN61000-3-3.  
Följer bestämmelserna i Direktiv 2006/95/EC och 2004/108/EC.

**•DECLARAÇÃO DE CONFORMIDADE****(Português)**

Declaramos sob nossa exclusiva responsabilidade que este produto, ao qual se refere esta declaração, se encontra em conformidade com as seguintes normas:  
EN60065, EN55013, EN55020, EN61000-3-2 e EN61000-3-3.  
De acordo com as disposições da Directiva 2006/95/CE e 2004/108/CE.

**DMi D&M Installation Europe**Kingsbridge House, Padbury Oaks Longford  
Middlesex UB7 0EH UK

### A NOTE ABOUT RECYCLING:

This product's packaging materials are recyclable and can be reused. Please dispose of any materials in accordance with the local recycling regulations.

When discarding the unit, comply with local rules or regulations.

Batteries should never be thrown away or incinerated but disposed of in accordance with the local regulations concerning battery disposal.

This product and the supplied accessories, excluding the batteries, constitute the applicable product according to the WEEE directive.

### HINWEIS ZUM RECYCLING:

Das Verpackungsmaterial dieses Produktes ist zum Recyceln geeignet und kann wieder verwendet werden. Bitte entsorgen Sie alle Materialien entsprechend der örtlichen Recycling-Vorschriften.

Beachten Sie bei der Entsorgung des Gerätes die örtlichen Vorschriften und Bestimmungen.

Die Batterien dürfen nicht in den Hausmüll geworfen oder verbrannt werden; bitte entsorgen Sie die Batterien gemäß der örtlichen Vorschriften.

Dieses Produkt und das im Lieferumfang enthaltene Zubehör (mit Ausnahme der Batterien!) entsprechen der WEEE-Direktive.

### UNE REMARQUE CONCERNANT LE RECYCLAGE:

Les matériaux d'emballage de ce produit sont recyclables et peuvent être réutilisés. Veuillez disposer des matériaux conformément aux lois sur le recyclage en vigueur.

Lorsque vous mettez cet appareil au rebut, respectez les lois ou réglementations en vigueur.

Les piles ne doivent jamais être jetées ou incinérées, mais mises au rebut conformément aux lois en vigueur sur la mise au rebut des piles.

Ce produit et les accessoires inclus, à l'exception des piles, sont des produits conformes à la directive DEEE.

### NOTA RELATIVA AL RICICLAGGIO:

I materiali di imballaggio di questo prodotto sono riutilizzabili e riciclabili. Smaltire i materiali conformemente alle normative locali sul riciclaggio.

Per lo smaltimento dell'unità, osservare le normative o le leggi locali in vigore.

Non gettare le batterie, né incenerirle, ma smaltirle conformemente alla normativa locale sui rifiuti chimici.

Questo prodotto e gli accessori inclusi nell'imballaggio sono applicabili alla direttiva RAEE, ad eccezione delle batterie.



Pb

### ACERCA DEL RECICLAJE:

Los materiales de embalaje de este producto son reciclables y se pueden volver a utilizar. Disponga de estos materiales siguiendo los reglamentos de reciclaje de su localidad.

Cuando se deshaga de la unidad, cumpla con las reglas o reglamentos locales.

Las pilas nunca deberán tirarse ni incinerarse. Deberá disponer de ellas siguiendo los reglamentos de su localidad relacionados con los desperdicios químicos.

Este producto junto con los accesorios empacutados es el producto aplicable a la directiva RAEE excepto pilas.

### EEN AANTEKENING MET BETREKKING TOT DE RECYCLING:

Het inpakmateriaal van dit product is recycleerbaar en kan opnieuw gebruikt worden. Er wordt verzocht om zich van elk afvalmateriaal te ontdoen volgens de plaatselijke voorschriften.

Volg voor het wegdoen van de speler de voorschriften voor de verwijdering van wit- en bruingoed op.

Batterijen mogen nooit worden weggegooid of verbrand, maar moeten volgens de plaatselijke voorschriften betreffende chemisch afval worden verwijderd.

Op dit product en de meegeleverde accessoires, m.u.v. de batterijen is de richtlijn voor afgedankte elektrische en elektronische apparaten (WEEE) van toepassing.

### OBSERVERA ANGÅENDE ÅTERVINNING:

Produktens emballage är återvinningsbart och kan återanvändas. Kassera det enligt lokala återvinningsbestämmelser.

När du kasserar enheten ska du göra det i överensstämmelse med lokala regler och bestämmelser.

Batterier får absolut inte kastas i soporna eller brännas. Kassera dem enligt lokala bestämmelser för kemiskt avfall.

Denna apparat och de tillbehör som levereras med den uppfyller gällande WEEE-direktiv, med undantag av batterierna.

## – TABLE OF CONTENTS –

1. GENERAL INFORMATION .....	2
FEATURES .....	2
PART NAMES AND FUNCTIONS .....	2
2. PREPARATIONS .....	6
INSTALLATION .....	6
CONNECTIONS .....	6
3. DEVICE OPERATION .....	7
FILE FORMAT FOR PLAYBACK .....	7
DISPLAYS INFORMATION .....	8
NORMAL PLAYBACK .....	9
ADVANCED PLAYBACK .....	10
PRESET FUNCTIONS AND OPERATIONS .....	13
4. TROUBLESHOOTING .....	14
5. SPECIFICATIONS .....	15

## ■ ACCESSORIES

Check first that the following accessories are included in the box:

- ① Remote Control Unit (RC-1135)..... 1

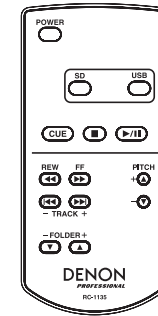

Lithium coin battery (CR2025 built-in)

- ② Stereo Audio Cable .....

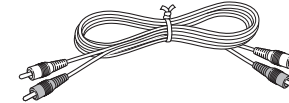

- ③ AC adaptor..... 1

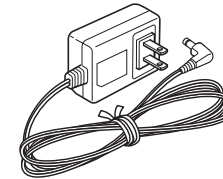

- ④ Feet .....

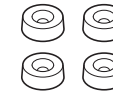

- ⑤ Screws for fixing the feet .....



- ⑥ Operating Instructions..... 1

- ⑦ CD-ROM for multi-language manuals..... 1

### A NOTE ABOUT RECYCLING:

This product's packaging materials are recyclable and can be reused. Please dispose of any materials in accordance with the local recycling regulations.

When discarding the unit, comply with local rules or regulations.

Batteries should never be thrown away or incinerated but disposed of in accordance with the local regulations concerning chemical waste.

This product and the accessories packed together constitute the applicable product according to the WEEE directive except batteries.





# 1. GENERAL INFORMATION

## FEATURES

### ■ Containing Standard Functions for an Institutional-Use Solid-State Player

- Playback of music files recorded on an SD card/SDHC card (see page 7)
- Playback of music files recorded on various media connected to the USB jack (see page 7)
- Supporting WAV, MP3 (MPEG-1 Layer III) (see page 7)
- Displaying the ID3 tags of MP3 (see page 8)
- Quick Track Search with Jog Wheel (see page 9)
- CUE function to return to the playback starting position (see page 12)
- Headphones output with trim (see page 2)
- Microphone input with trim (one on the front panel and the other on the rear panel) (see page 2 and 3)
- Analog audio output with trim (see pages 2 and 3)
- Paging function to decrease the playback audio output level by 20 dB automatically when using a microphone (see page 13)
- Microphone mute function to mute the microphone input automatically when the microphone input level is -60 dBV or less (see page 13)
- User memory function for storing various settings when the power is turned off (see page 8 and 9)
- Monaural audio output function that mixes the left- and right-channels and outputs them from the L- and R-output jacks (see page 13)

### ■ Advanced Playback

- $\pm 20\%$  variable pitch control in 0.1% steps (see page 12)
- Tempo Lock Function to Retain the Normal Pitch by Compensating the Pitch Variation by Pitch Control (see page 12)
- Selectable play mode (All Tracks, All Tracks in a Folder, Single Track, Random All Tracks, Random Tracks in a Folder) (see page 10)
- Repeat function (A-B section setting, various play mode) (see page 11)
- Auto cue (auto audio level search) (see page 13)
- Power ON play (See page 13)
- Next track reserve playback (see page 12)

### ■ 19-inch 1U Rack Mount

### ■ IR Remote Control (Remote Controller RC-1135 Included)

## PART NAMES AND FUNCTIONS

### Front panel

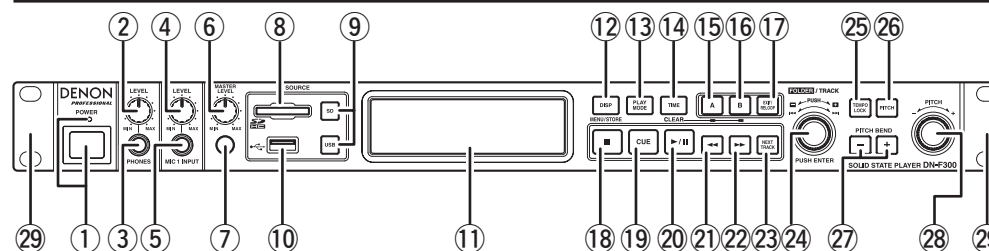

### ① POWER switch and indicator

- Press this button to turn the power on or off.
- The indicator lights when the power is turned on.

### ② LEVEL control

- Use this knob to adjust the output level of the headphones.
- Push the knob. The knob pops out and controls the level. When control is finished, push the knob back in.

### Warning!

- When using headphones, take care not to turn the volume too high. Listening at high volumes for extended periods of time may result in permanent hearing damage.

### ③ PHONES jack

- You can connect your headphones to this jack. (Stereo phone 1/4" jack)

### ④ LEVEL control

- Use this knob to adjust the input level of the microphones.
- This knob controls the level of the microphones connected via the MIC 1 INPUT and MIC 2 INPUT jacks simultaneously.
- Push the knob. The knob pops out and controls the level. When control is finished, push the knob back in.

### ⑤ MIC1 INPUT jack

- Connect a microphone to this jack. (Monaural phone 1/4" jack, dynamic microphone)

### ⑥ MASTER LEVEL control

- Use this knob to adjust the audio output level.
- Push the knob. The knob pops out and controls the level. When control is finished, push the knob back in.

### ⑦ Remote control sensor



- ⑧ **SD slot**
  - Insert an SD card into the slot, label side upwards.
- ⑨ **SD/USB input select buttons and indicators (SD: Green, USB: Amber)**
  - Press either of the buttons to select an input source.
- ⑩ **USB connector**
  - Connect a USB device to this jack. (See page 9)
- ⑪ **Display unit**
- ⑫ **DISP/MENU/STORE button**
  - Press this button to change the text display mode. (See page 8)
  - Hold the button pressed for more than 2 seconds to enter in preset menu mode. (See page 13)
- ⑬ **PLAY MODE button**
  - Press this button to select the track play mode. (See page 10)
- ⑭ **TIME/CLEAR button**
  - Press this button to select the time mode on the display unit. (See page 8)
  - Press the A or B button while pressing this button to clear the A-B point or B point.
- ⑮ **A button**
  - Press this button to set the start point (A point) of the A-B REPEAT play.
- ⑯ **B button**
  - Press this button to set the end point (B point) of the A-B REPEAT play.
- ⑰ **EXIT/RELOOP button**
  - EXIT: Press this button to cancel the A-B REPEAT play.
  - RELOOP: Press this button to restart the A-B REPEAT play.
- ⑱ **■ button**
  - Press this button to stop playback.
  - Press this button during preset menu setting to cancel input, and to enter in stop mode.
- ⑲ **CUE button and indicator (Amber)**
  - When this button is pressed during playback, the pickup returns to the playback start point or to the top of the reserved track if the next track has been reserved by pressing of the NEXT TRACK button. (See page 12)
- ⑳ **▶/|| button and indicator (Green)**
  - Press this button to start playback or pause playback.
- ㉑ **◀◀ button**
  - Hold the button pressed to start playback as FR.

- ㉒ **▶▶ button**
  - Hold the button pressed to start playback as FF.
- ㉓ **NEXT TRACK button and indicator (Amber)**
  - Press this button to reserve the next track.
- ㉔ **FOLDER/TRACK jog wheel**
  - Turn the jog wheel to skip the track or to change the menu item.
  - Turn the jog wheel while holding down to skip the folder.
  - Push the jog wheel to confirm the settings in menu mode.
- ㉕ **TEMPO LOCK button and indicator (Amber)**
  - Press this button to lock the pitch of the playback sound.
- ㉖ **PITCH button and indicator (Amber)**
  - Press this button to switch the PITCH control ON or OFF.
- ㉗ **PITCH BEND +/- buttons**
  - Hold the button pressed to control the playback speed. When the button is released, the original speed is resumed.
- ㉘ **PITCH jog wheel**
  - Turn the jog wheel to control the playback speed.
- ㉙ **Rack mount bracket**
  - If the unit is not mounted to a 19-inch rack, remove the brackets.

**Rear panel**

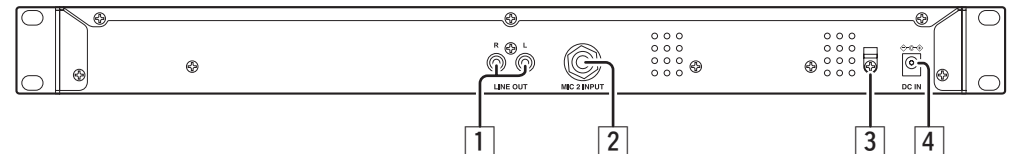

- 1 **LINE OUT**
  - These are analog unbalanced outputs using RCA type pin jacks.
- 2 **MIC2 INPUT jack**
  - Connect a microphone. (Monaural phone 1/4" jack, dynamic microphone)
- 3 **DC power cord clamber**
- 4 **DC power inlet**
  - Connect the included AC power adaptor.

## 1. GENERAL INFORMATION

### Display

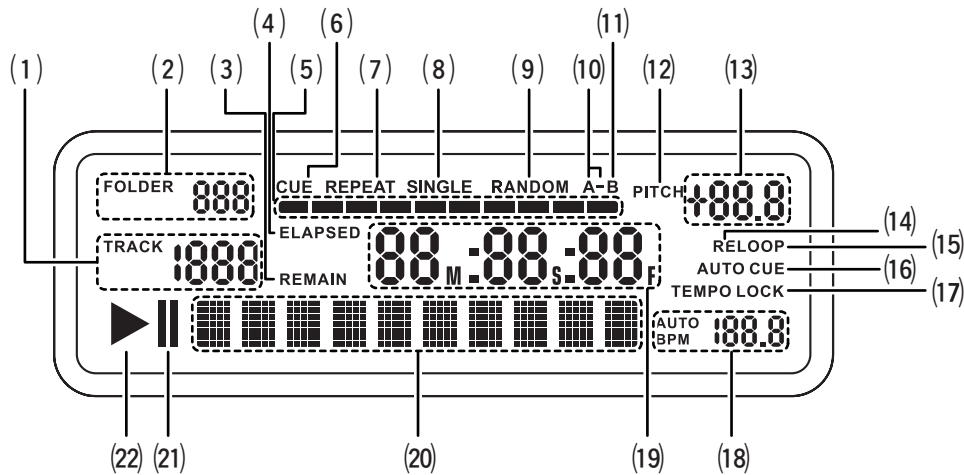

(1) **Track number display**

- Displays the track number.

(2) **Folder number display**

- Displays the folder number.

(3) **REMAIN indicator**

- Lights to indicate that the remaining time display mode is selected.

(4) **ELAPSED indicator**

- Lights to indicate that the elapsed time display mode is selected.

(5) **Play position display**

- Displays the current position on the playing track.

(6) **CUE indicator**

- Lights when CUE mode is on.

(7) **REPEAT indicator**

- Lights when playback mode is repeat playback.

(8) **SINGLE indicator**

- Lights when playback mode is SINGLE playback.

(9) **RANDOM indicator**

- Lights when the playback mode is random playback (all track random playback, random folder playback).

(10) **A-point indicator**

- Flashes when the A point of the A-B repeat playback is set. The indicator lights when the B point is set.

(11) **B-point indicator**

- Lights when the B point of the A-B repeat playback is set.

(12) **PITCH indicator**

- Lights when the pitch control is set to on.

(13) **PITCH setting display**

- Displays the +/- PITCH level (%).

(14) **RE indicator**

- Lights during RELOOP play.

(15) **LOOP indicator**

- Flashes during A-B repeat playback.

(16) **AUTO CUE indicator**

- Lights when AUTO CUE mode is set to on.

(17) **TEMPO LOCK indicator**

- Lights when TEMPO LOCK is set to on.

(18) **AUTO BPM setting display**

- Displays the AUTO BPM.

(19) **Time display**

- Displays the time (minute, second, frame).

(20) **Main information display**

- Displays the folder name, filename, ID3 tags and status information.

(21) **PAUSE indicator**

- Flashes in pause mode.

(22) **PLAY indicator**

- Lights in play mode.

**Remote control unit (RC-1135)**

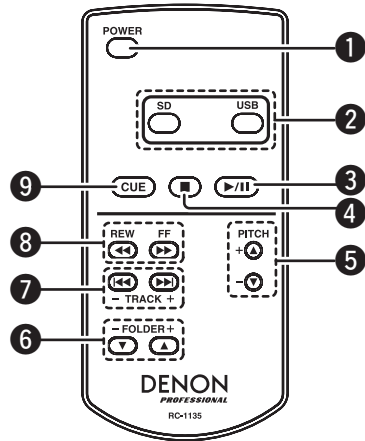

**1 POWER button**

Press this button to turn the power on or off.

**2 SD/USB input select buttons**

Press either of the buttons to select an input source.

**3 ►/II button**

Press this button to start playback or pause playback.

**4 ■ button**

Press this button to stop playback.

**5 PITCH +/- buttons**

Press this button to change the playback speed.

**6 FOLDER +/- buttons**

Press this button to skip a folder.

**7 TRACK +/- buttons**

Press this button to skip a track.

**8 FF/REW button**

- Press this button to accurately change the position when playback will start.
- Hold the button pressed to start playback as FF or FR.

**9 CUE button**

Press this button to move to the playback start point.

**• BEFORE USING THE REMOTE CONTROL UNIT**

A lithium battery comes installed in the remote control unit. Before use, pull out the insulation sheet.

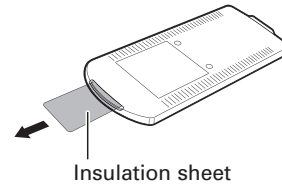

**• BATTERY REPLACEMENT**

If the battery of the remote control unit is exhausted, the operable distance of the remote control unit becomes extremely short. In such a case, replace the battery with a new one.

1. Slide out the battery holder from the remote control by pushing into the hole in the holder with a ball-point pen, etc.
2. Pull out the old lithium battery from the battery case and insert a new one. Place the battery so that the + (positive) side faces upward.
3. Replace the battery case in its original position.

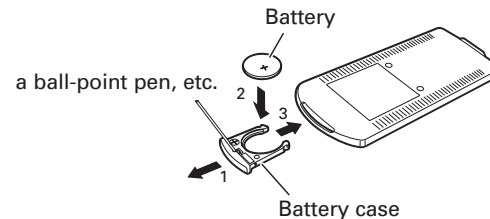

**• OPERABLE RANGE OF THE REMOTE CONTROL UNIT**

The operable range of the remote control unit is shown in the figure below.

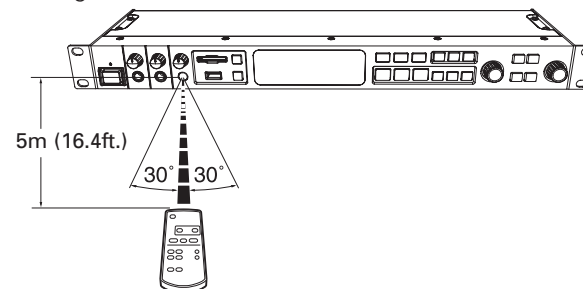

**Notes On Use**

- Do not allow direct sunlight, an inverter fluorescent light or other strong light to shine onto the unit's infrared signal reception window (remote sensor). Doing so may disable operation of the remote controller.
- Note that operating the remote controller may cause other devices operated by infrared rays to be operated by mistake.
- The remote controller cannot be operated if the line of sight between the remote controller and the unit's remote sensor is obstructed.
- Do not place any objects on top of the remote controller. Doing so may cause one or more buttons to be held down, which will cause the battery to run down.

**• CAUTIONS ON HANDLING BATTERIES**

Misuse of the lithium battery can result in heat buildup, ignition, or rupture. Bear in mind the following points when using or replacing batteries.

- The supplied battery is for testing the functionality of the remote controller.
- Use a CR2025 lithium battery.
- NEVER recharge the battery.
- Do not handle the battery roughly or deconstruct the battery.
- When replacing the battery, place it with correct polarity (+ and -).
- Do not leave the battery in a place subject to high temperature, such as a place subject to direct sunlight.
- Keep the battery in a place beyond infants' or children's reach. If a battery is swallowed, consult a physician immediately.
- If electrolyte has leaked, discard the battery immediately. Be careful when handling such a battery, because if the electrolyte is attached to your skin or clothes, you may be burned. If it is accidentally attached, immediately wash with tap water then consult a physician.
- When a battery which is no longer required is to be discarded, insulate it with tape, etc. and dispose of it in a place without fire, by following the directions (regulations) laid down by the local authorities in the area concerned for its disposal.

## 2. PREPARATIONS

### INSTALLATION

#### ■ Mounting in a rack

- The DN-F300 is of 1U size, allowing it to be mounted in EIA standard 19-inch racks.
- Do not cover the top of the unit. Remember, heat is dispersed from the DN-F300's upper surface.
- Set up the installation environment carefully. For example, take care to protect the DN-F300 from heat from other devices. If necessary, use forced ventilation. The surrounding conditions must meet the specifications described in "SPECIFICATIONS" on Page 15.
- If the DN-F300 is placed near an amplifier, tuner or other components, noise (induced hum) or beat interference may result (especially during AM or FM reception). If interference occurs, disconnect the DN-F300 or change the installation place.
- If the unit is not to be mounted in a rack, remove the rack mount brackets and attach the included feet.

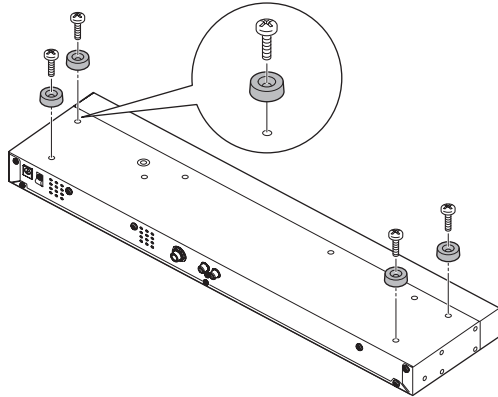

### CONNECTIONS

#### ■ Connection precautions

- Before proceeding with connections or disconnections of cables and AC adaptor, be sure to turn all system components off.
- Ensure that analog audio cables are connected properly to the L (left) and R (right) jacks.
- Insert plugs fully into the terminals.
- Connect the output jacks to the amplifier CD or AUX input jacks.

#### ■ Basic connection

##### 1. Rear panel

Secure the cable connection of the AC adaptor with the clamp it to avoid its becoming disconnected from the DC power input.

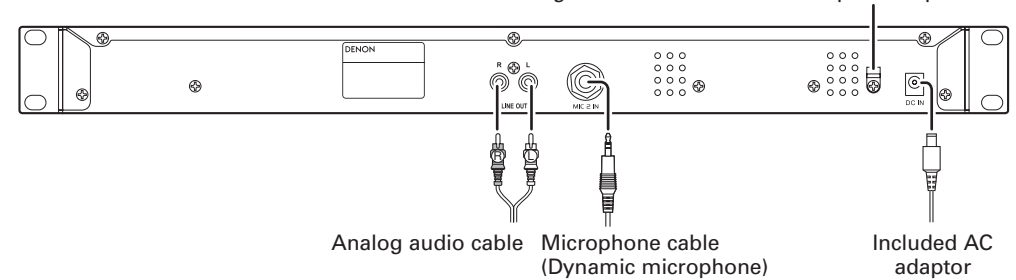

##### 2. Front panel

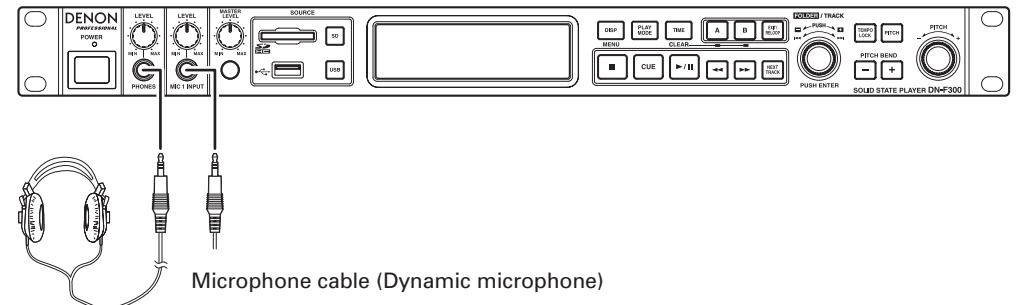

#### CAUTIONS:

- Before connecting, the POWER ON/OFF switch should be set the OFF position.
- Do not touch the power cord with wet hands.
- When disconnecting the power cord, always make sure that you take hold of the plug. Yanking out or bending the cord can damage it and/or cause electric shocks or a fire.

# 3. DEVICE OPERATION

## FILE FORMAT FOR PLAYBACK

### ■ PCM file format

Format	Sampling frequency	Quantization Bit number	Channel	Bit rate	File extension
PCM	44.1kHz	16bit	Stereo	–	wav
			Mono	–	wav

### ■ MP3 file format

Format	Sampling frequency	Quantization Bit number	Channel	Bit rate (kbps)	File extension
MP3	44.1kHz	16bit	Stereo	32, 40, 48, 56, 64, 80, 96, 112, 128, 160, 192, 224, 256, 320, VBR	mp3
			Mono		mp3

### ■ Format

Media	Logical format
SD	FAT16, FAT32
SDHC (32 GB maximum)	
USB memory device	
USB HDD	

### ■ Handled audio files as “track” and playing audio file

- A folder (also called a “directory”) is a hierarchical level.
- After setting media device and searching for all audio files, the DN-F300 assigns each audio file a track number.
- For example in the illustration below, at first each audio file is assigned a track number.
- Folder-AAA, folder-BBB, and folder-DDD contain audio files and can be selected for operations. But folder-CCC is excluded from operations. Folder-CCC does not contain audio files, and is excluded from operations.

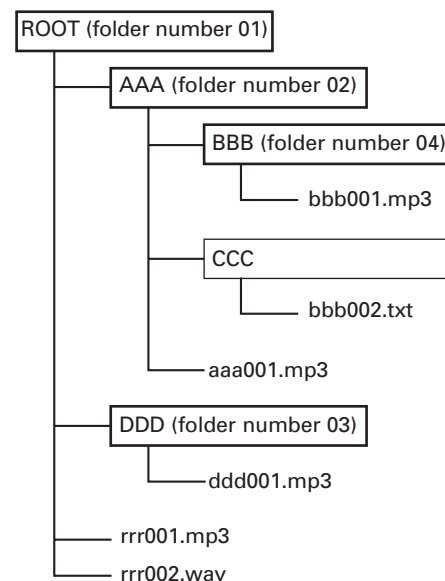

- The maximum number of folders is 999 (including the root directory).
- If 2,000 or more files exist, files 1 to 1,999 will be played. Files 2,000 and after will not be played back.
- Folder layers are a maximum of 9 (including the root directory)
- A filename can be 63 characters in full path. (alphabets in capital and lower-case letters, numerics, symbols (complying with FAT))
- A folder that does not include the file to be played has no folder number.

### 3. DEVICE OPERATION

## DISPLAYS INFORMATION

When a media device is inserted into the DN-F300, various kinds of information are displayed on the display unit.

### ■ Time display

The folder number, track number, and elapsed time (remaining time) are displayed. When in play or pause mode, the following information is displayed in order by pressing the TIME/CLEAR button.

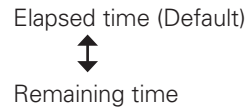

When the power is turned off, the current time mode is saved. When the power is turned on again, the saved time display mode is resumed. (User memory function)

### ■ Text information display

When a media device with MP3 files recorded is inserted into the DN-F300, various kinds of information are displayed in addition to the time display on the display unit. This information is recorded in an MP3 file as an ID3 tag.

When in playback, pause, or search mode, the following information is displayed in order by pressing the DISP/MENU button.

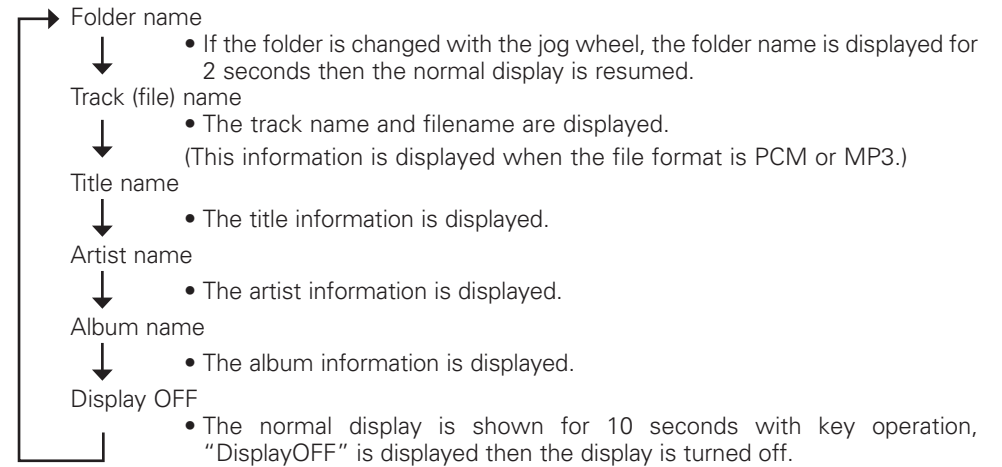

When the power is turned off, the current text display mode is saved. When the power is turned on again, the saved text display mode is resumed. (User memory function)

#### Note:

- If a file in which ID3 information is not recorded correctly is played, the text information may not be displayed.
- Two-byte characters like Japanese are not displayed correctly.

## NORMAL PLAYBACK

### Before starting playback

1. Press the POWER switch to turn on the power.  
The POWER indicator flashes for 1 second then lights. All items on the display light up. If medium is detected, the time display and text information are displayed. If none is detected, "No Source" is displayed.

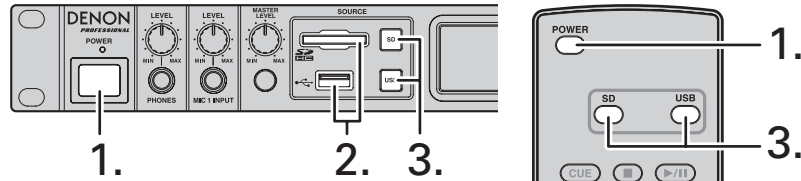

2. For playing back an SD card, insert the SD card in the SD card slot. For playing back a USB device, connect the USB device to the USB jack.
3. Press the button for the input source to be played (SD or USB button).
  - When the input source is selected, folder numbers of all folders in the selected source are displayed for 2 seconds. Then the settings for that played last are displayed. ("Unformat" is displayed for any format other than FAT16 or FAT32.)
4. Make sure the Preset settings are set according to the intended use. (See page 13)

### Starting playback

1. Turn the FOLDER/TRACK jog wheel to select a track to be played.
2. Press the ►/|| button. The button lights in green and playback of a track starts.

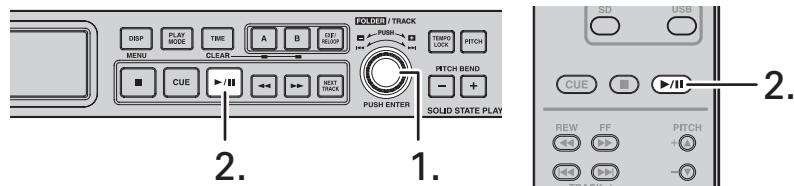

- When the ►/|| button is pressed with the CUE button lit, CUE mode (instant playback start mode) is on. (See page 12)

### Pausing playback

1. Press the ►/|| button during playback.
  - The ►/|| button flashes.
2. Press the ►/|| button to continue playback.
  - Playback restarts from the paused point.

### Stopping playback

1. Press the ■ button on the front panel or the remote control unit.

### Advancing to the next track during playback

1. Turn the FOLDER/TRACK jog wheel clockwise.

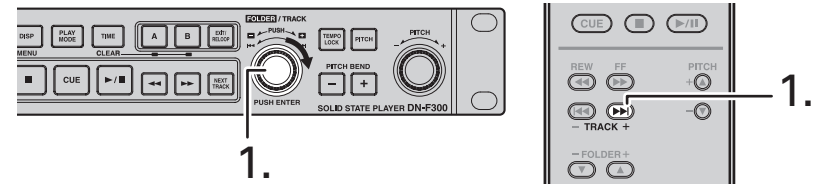

- The next track is played.

### Returning to the beginning of the current track during playback

1. Turn the FOLDER/TRACK jog wheel counterclockwise.

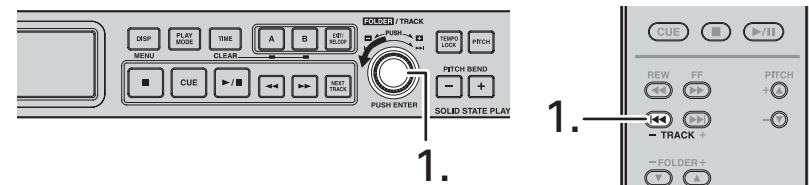

- The pickup will return to the beginning of the current track and playback will continue.



### 3. DEVICE OPERATION

#### Audible quick search

- Using this function, you can search for a desired point within a track in the both forward or reverse direction.
- When the ►► button is pressed in pause mode, the pause mode is canceled at that point with the sound in search mode being played.

#### Manual search forward

1. Press the ►► button during playback.

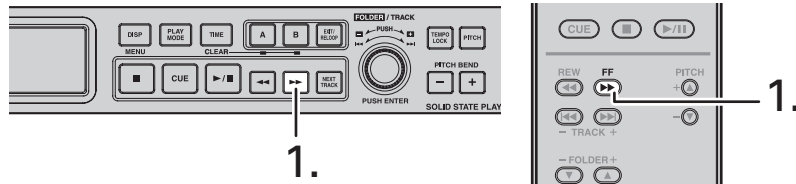

- Every time the ►► button is held pressed (for less than 1 second), the playback point advances one frame. When the button is held pressed for a long period, playback is in FF mode. Playback speed increases in 3 steps (about 2 times, 10 times, and 40 times).

#### Manual search in reverse

1. Press the ◀◀ button during playback.

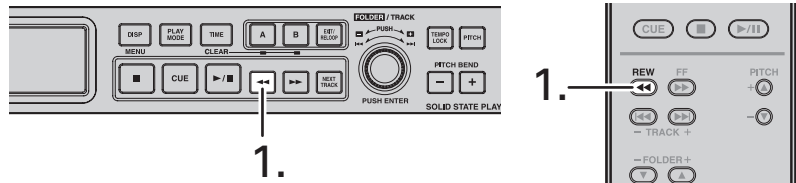

- Every time the ◀◀ button is held pressed (for less than 1 second), the playback point retreats one frame. When the button is held pressed for a long period, playback is in FR mode. Playback speed increases in 3 steps (about 2 times, 10 times, and 40 times).

## ADVANCED PLAYBACK

### Playback with the PLAYMODE button

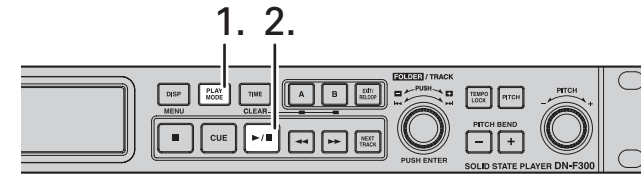

Each time the PLAYMODE button is pressed, the playback range and random playback mode are changed.

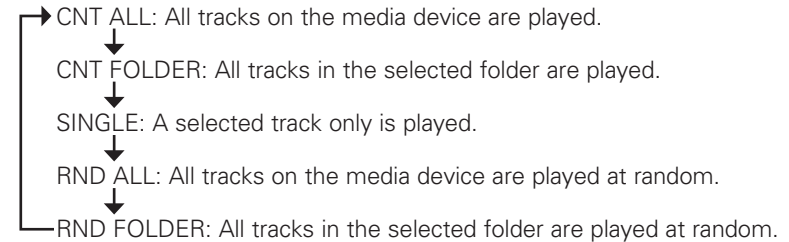

#### (1) All track playback, all track random playback

1. Press the PLAY MODE button to select "CNT ALL" or "RND ALL".
  - The RANDOM indicator lights during all track random playback.
2. Press the ► / || button.
  - Playback starts.

#### (2) Folder playback, random folder playback

1. Press the PLAY MODE button to select "CNT FOLDER" or "RND FOLDER".
  - The RANDOM indicator lights during random folder playback.
2. Press the ► / || button.
  - Playback starts.

#### (3) Single track playback

1. Press the PLAYMODE button to select "SINGLE".
  - The SINGLE indicator lights during SINGLE playback.
2. Press the ► / || button.
  - Playback starts.

**Repeating playback**

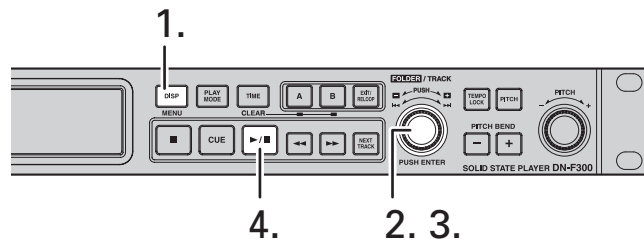

Repeat playback in each playback mode can be set. (See page 13)

1. Hold the DISP/MENU button pressed for about 2 seconds.
  - Preset menu mode is activated.
2. Display "Repeat Play" with the FOLDER/TRACK jog wheel, then press the wheel.
3. Select "On" with the jog wheel, then press the wheel.
  - Repeat playback is set.
  - To release repeat playback, select "Off".
4. Press the ► / || button.
  - Repeat playback starts.

**Repeating playback of a specific section within a track (A-B repeat)**



1. During playback, press the A button at the point where you want to start repeat playback (A point).
  - The "A-" indicator flashes on the display.
  - After setting the A point, press the A button during playback. Playback will start from the A point.
2. During playback, press the B button at the point where you want to end repeat playback (B point).
  - The "A-B" and "RE" indicators light, the "LOOP" indicator flashes, and A-B repeat playback starts.
  - If A-B repeat playback is set in random playback mode or repeat playback mode, each mode is temporarily canceled.
  - To release A-B repeat playback, press the EXIT/RELOOP button.
  - If the ■ button is pressed after the A-B section is set, A-B repeat playback is canceled.
  - If the EXIT/RELOOP button is pressed again after canceling the A-B repeat playback, the A-B repeat playback restarts.
  - If the A or B button is pressed while the TIME/CLEAR button is held pressed after the A-B section has been set, the A and B points or B points are canceled.
  - If the A button is pressed while the TIME/CLEAR button is held pressed after the A point has been set, the A point is canceled.
  - If the power is turned off after setting the A-B section, the A-B section setting is canceled.
  - When the A-B section is canceled, the previous playback mode is resumed.

**Warning!**

- If the track is VBR, the A-B section setting is disabled. ("VBR" is displayed on the display for about 3 seconds.)

### 3. DEVICE OPERATION

#### Pitch Control

Pitch Control allows playback of audio at faster (+) or slower speed (-).

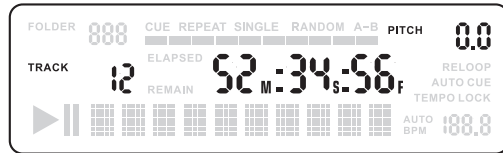
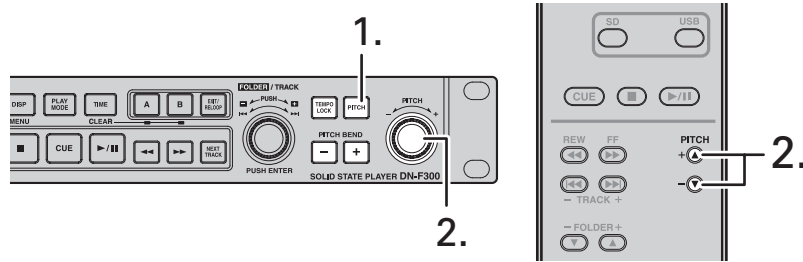

1. Press the PITCH button.
  - The PITCH button lights in amber, indicating that PITCH CONTROL is on.
  - Press the PITCH button again to turn PITCH CONTROL off. The PITCH button turns off.
2. Turn the jog wheel to control the playback speed.
  - Clockwise: Playback speed increases. Counterclockwise: Playback speed decreases.
  - Adjustable range: -20.0 to 0 to +20.0

#### Other operations

- **Tempo lock**  
Press the TEMPO button to lock the key and the pitch with the original sound.
- **PITCH BEND +/- button**
  - Press the PITCH BEND +/- button to change the playback speed temporarily.
  - While the PITCH BEND + button is held pressed, the playback speed is increased, and while the PITCH BEND - button is held pressed, the playback speed is decreased.
  - Release the PITCH BEND +/- button to retrieve the original playback speed.

#### Next track reserve

During playback, the next track is reserved and played.

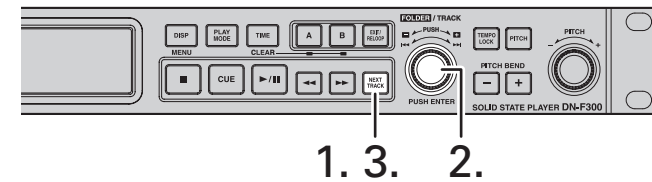

1. Press the NEXT TRACK button during playback. The "Next Track" is displayed on the display for 2 seconds to indicate that the next playback track is reserved.
  - The NEXT TRACK button lights.
2. Select a folder and track, using the FOLDER/TRACK jog wheel.
  - Folder number and track number flash.
3. Press the NEXT TRACK button again to cancel the next track reservation, and the NEXT TRACK button turns off.

#### Returning to the position at which playback started

1. Press the CUE button during playback, then the pickup returns to the playback start position.

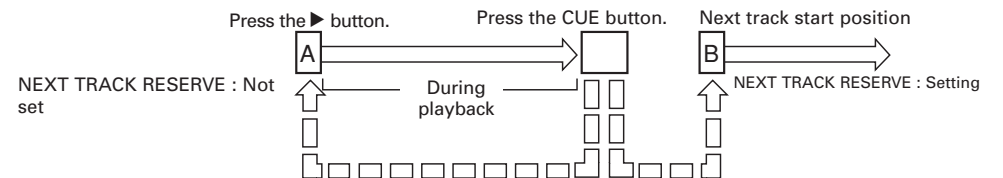
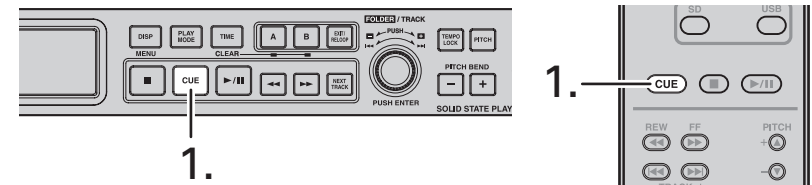

- When the next track reserve is set:  
Press the CUE button during playback. The pickup returns to the top point of the set track number (B point), and playback starts.
- When the next track reserve is not set:  
Press the CUE button during playback. The pickup returns to the point where the 2 button was pressed (A point) then playback starts.

- Auto cue function:  
When the pickup returns to the playback start point after you press the CUE button during playback, the playback sound at the top of the target track is detected, and the pickup moves to the point where the playback sound starts and playback starts. (See page 13)

## PRESET FUNCTIONS AND OPERATIONS

### Changing the PRESETS

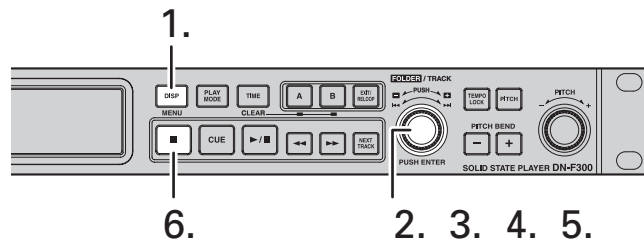

1. Press and hold the DISP/MENU button for about 2 seconds in stop mode.
  - The unit enters in preset menu mode.
2. Turn the FOLDER/TRACK jog wheel to select the preset item you wish to modify.  
Power On ↔ Repeat Play ↔ Auto Cue ↔ MIC Mute ↔ Paging ↔ Mono ↔ Default (factory setting) ↔ F/W Version
3. Press the FOLDER/TRACK jog wheel to confirm your selection.
  - Preset setting data flash on the display.
4. Turn the FOLDER/TRACK jog wheel to select the setting of the preset item.
5. Press the FOLDER/TRACK jog wheel to confirm your setting.  
Repeat steps 2 to 5 as needed.
6. Press the DISP/MENU button to save changes after making settings.
  - During saving "Executing" is displayed.
  - When saving is finished, "Completed" is displayed on the display unit for 1 second. "F/W Version" is excluded.
  - Press the ■ button in the preset menu mode to cancel the settings and to return to the stop mode.

### Table of Preset Items and Default settings

No	Display	Setting items	Contents
1.	Power On	Play	The unit starts to play after boot procedure is completed.
		Stop (Default)	The unit sits in stop mode after boot procedure is completed.
2.	Repeat Play	On	The unit sets the repeat playback on. (See page 11)
		Off (Default)	The unit sets the repeat playback off.
3.	Auto Cue	On	The unit detects the playback sound of the top of the target track when the pickup returns to the playback start point after you press the CUE button during playback, and the pickup returns to the point where the playback sound starts. (See page 12)
		Off (Default)	The unit does not detect the playback sound of the target track when the CUE button is pressed during playback, and the pickup returns to the playback start position.
4.	MIC Mute	On (Default)	The unit automatically mutes the microphone input when microphone input level is -60 dBV or less.
		Off	The unit sets the microphone input mute mode off.
5.	Paging	On (Default)	The unit sets the playback audio output level muted by 20 dB automatically when a microphone is used.
		Off	The unit sets audio output level mute mode to off when a microphone is used.
6.	Mono	On	The unit outputs L and R mixed signals from the output jacks.
		Off (Default)	The unit outputs L and R signals from the output jacks.
7.	Default	-	The unit returns the preset data to the default values (the value when you purchased).
8.	F/W Version	F/W Version	The unit displays the firmware version.

## 4. TROUBLESHOOTING

Make sure of the followings before you consider as any malfunctions :

1. Are all the connections correct?
2. Are all system components being operated correctly in accordance with the operating instructions?
3. Are the speakers and amplifier functioning correctly?

If the Unit still does not function properly, check the symptom against the list below. If the symptom is not covered on the check list, contact your dealer or service centers. Service centers are listed at <http://www.d-mpro.com>.

Problem	Display	Cause	Remedy
Media is not detected.	No Source	<ul style="list-style-type: none"> <li>• A SD card is not inserted correctly.</li> <li>• A USB drive is not connected correctly.</li> </ul>	<ul style="list-style-type: none"> <li>• Remove and reinsert the media.</li> <li>• Connect a USB drive correctly again.</li> </ul>
The file cannot be displayed.	No Track	<ul style="list-style-type: none"> <li>• The playback file has some problem.</li> </ul>	<ul style="list-style-type: none"> <li>• Check if the file is recorded correctly.</li> </ul>
Media error	Unformat	<ul style="list-style-type: none"> <li>• An inserted SD card or USB drive cannot be recognized.</li> </ul>	<ul style="list-style-type: none"> <li>• Use the normally recorded and applicable media.</li> </ul>
FWD/RWD is disabled.	VBR	<ul style="list-style-type: none"> <li>• A VBR file is in FWD or RWD.</li> </ul>	<ul style="list-style-type: none"> <li>• Check the MP3 file.</li> </ul>
File error is displayed.	TrackError	<ul style="list-style-type: none"> <li>• File format error</li> </ul>	<ul style="list-style-type: none"> <li>• Check the file format.</li> </ul>
EEPROM error is displayed.	EEPROM Err	<ul style="list-style-type: none"> <li>• EEPROM Read/Write error</li> </ul>	<ul style="list-style-type: none"> <li>• Request servicing.</li> </ul>
Updating error is displayed.	UpdateErr1	<ul style="list-style-type: none"> <li>• Updating operation is disabled.</li> </ul>	<ul style="list-style-type: none"> <li>• Check the updating file.</li> </ul>
Updating error is displayed.	UpdateErr2	<ul style="list-style-type: none"> <li>• Writing to ROM is failed.</li> </ul>	<ul style="list-style-type: none"> <li>• Request servicing.</li> </ul>
Internal error is displayed.	E XXXXXXXX	<ul style="list-style-type: none"> <li>• Internal error occurs.</li> </ul>	<ul style="list-style-type: none"> <li>• Request servicing.</li> </ul>

\*Warning: Normal start up may not be obtained on some USB HDD.

# 5. SPECIFICATIONS

## ■ SYSTEM

<b>Playback Media:</b>	SD/SDHC, USB drives
<b>Playback File Format :</b>	WAV, MP3 (MPEG-1 Layer III)
<b>Media Format :</b>	FAT/FAT32
<b>MP3 Bit Rate :</b>	32-320 kbps/Stereo, VBR
<b>Sampling Frequency :</b>	44.1 kHz
<b>Quantization :</b>	16 bit

## ■ AUDIO SECTION

<b>Audio channel:</b>	2 (Stereo) / 1 Monaural
<b>Frequency response :</b>	20 to 20,000 Hz ± 1.0 dB
<b>Dynamic range :</b>	96 dB
<b>Signal-to-noise Ratio :</b>	97 dB (1 kHz, 0 dB playback, A filter)
<b>Channel separation :</b>	89 dB (1 kHz, 0 dB playback)
<b>Total Harmonic Distortion :</b>	0.006% (1 kHz, 0 dB playback)
<b>Line Output (RCA):</b>	2.0 Vrms (0 dB) / 1 kohm (Level Control Max)
<b>Microphone input sensitivity/input impedance:</b>	-38 dBV/10 kohm (Level Control Max)
<b>Headphone Output :</b>	20 mW / 32 ohms (Level Control Max)
<b>Variable Pitch Control :</b>	±20.0% (0.1% steps)
<b>Frame Search Accuracy :</b>	1 / 75 second

## ■ GENERAL

<b>Power Source:</b>	DC6 V
<b>Power Consumption :</b>	12 W
<b>Dimensions (W x H x D) incl. rack kits :</b>	482 (19") x 44(1-12/16") x 129 (5") mm
<b>Weight :</b>	1.6 kg (3 lbs 9 oz)

## ■ ENVIRONMENTAL CONDITIONS

<b>Operating temperature :</b>	+5°C to +35°C
<b>Operating humidity :</b>	25% to 85%, non condensing
<b>Storage temperature :</b>	-20°C to +60°C
<b>Storage humidity :</b>	25% to 85%, non condensing

## ■ DIMENSIONS

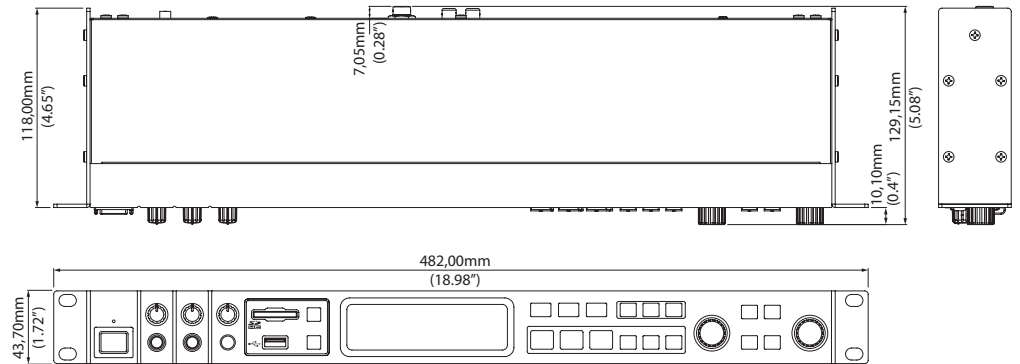

### Note:

- Some part may not be played back correctly depending on the format or recording status.
- For improvement purposes, specifications and design are subject to change without notice.

D&M Holdings Inc.

