

evolutionwireless 

EM 500



Contents

Important safety instructions	2
The EM 500 G3 rack-mount receiver	5
Areas of application	5
The frequency bank system	6
Delivery includes	8
Product overview	9
Overview of the EM 500 G3 receiver	9
Overview of the displays	10
Putting the receiver into operation	12
Preparing the receiver for use	12
Connecting an amplifier/mixing console	17
Connecting receivers in a network	18
Connecting the mains unit	20
Using the receiver	21
Switching the receiver on/off	21
Monitoring the audio signal via headphones	22
Synchronizing a transmitter with the receiver	23
Deactivating the lock mode temporarily	24
Muting the audio signal	25
Selecting a standard display	26
Using the operating menu	27
The buttons	27
Overview of the operating menu	28
Working with the operating menu	30
Adjustment tips and functions	32
Standard displays with additional functions	32
The main menu "Menu"	35
The extended menu "Advanced Menu"	40
Synchronizing transmitters with receivers	46
Synchronizing a transmitter with the receiver – individual operation	46
Synchronizing transmitters with receivers – multi-channel operation	47
Cleaning the receiver	50
Recommendations and tips	51
If a problem occurs	52
Accessories and spare parts	54
Specifications	56
Manufacturer Declarations	59
Index	61



An animated instruction manual can be viewed on the EM 500 G3 product page on our website at www.sennheiser.com.

Important safety instructions

- Read this instruction manual.
- Keep this instruction manual. Always include this instruction manual when passing the product on to third parties.
- Heed all warnings and follow all instructions in this instruction manual.
- Only clean the product when it is not connected to the mains. Use a cloth for cleaning.
- Refer all servicing to qualified service personnel.
Servicing is required if the product has been damaged in any way, liquid has been spilled, objects have fallen inside, the product has been exposed to rain or moisture, does not operate properly or has been dropped.
- **WARNING:** To reduce the risk of short circuits, do not use the product near water and do not expose it to rain or moisture. Do not place objects filled with liquids, such as vases or coffee cups, on the product.
- Only use the supplied mains unit.
- Unplug the mains unit from the wall socket
 - to completely disconnect the product from the mains,
 - during lightning storms or
 - when unused for long periods of time.
- Only operate the mains unit from the type of power source specified in the chapter “Specifications” (see page 55).
- Ensure that the mains unit is
 - in a safe operating condition and easily accessible,
 - properly plugged into the wall socket,
 - only operated within the permissible temperature range,
 - not covered or exposed to direct sunlight for longer periods of time in order to prevent heat accumulation (see “Specifications” on page 55).
- Do not block any ventilation openings. Install the product in accordance with the instructions given in this instruction manual.
- Do not install the product near any heat sources such as radiators, stoves, or other devices (including amplifiers) that produce heat.
- Only use attachments/accessories specified by Sennheiser.

Overloading

Do not overload wall outlets and extension cables as this may result in fire and electric shock.

Replacement parts

When replacement parts are required, be sure the service technician uses replacement parts specified by Sennheiser or those having the same characteristics as the original part. Unauthorized substitutions may result in fire, electric shock, or other hazards.

Danger due to high volumes

This product is capable of producing sound pressure exceeding 85 dB(A). 85 dB(A) is the sound pressure corresponding to the maximum permissible volume which is by law (in some countries) allowed to affect your hearing for the duration of a working day. It is used as a basis according to the specifications of industrial medicine. Higher volumes or longer durations can damage your hearing. At higher volumes, the duration must be shortened in order to prevent hearing damage. The following are sure signs that you have been subjected to excessive noise for too long a time:

- You can hear ringing or whistling sounds in your ears.
- You have the impression (even for a short time only) that you can no longer hear high notes.

Intended use

Intended use of the ew 500 G3 series products includes:

- having read these instructions especially the chapter “Important safety instructions”,
- using the products within the operating conditions and limitations described in this instruction manual.

“Improper use” means using the products other than as described in this instruction manual, or under operating conditions which differ from those described herein.

The EM 500 G3 rack-mount receiver



This receiver is part of the evolution wireless series generation 3 (ew G3). With this series, Sennheiser offers high-quality state-of-the-art RF transmission systems with a high level of operational reliability and ease of use. Transmitters and receivers permit wireless transmission with studio-quality sound.

Features of the evolution wireless 500 G3 series:

- Optimized PLL synthesizer and microprocessor technology
- HDX noise reduction system
- Pilot tone squelch control
- True diversity technology
- Switching bandwidth of 42 MHz
- Safe configuration of a multi-channel system via a network
- Scan function (Easy Setup) for scanning the frequency banks for unused channels

Areas of application

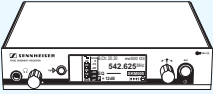
The receiver can be combined with the following optional components of the ew G3 series (see "Accessories and spare parts" on page 53):

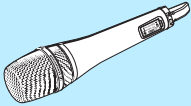
Receiver	Transmitters	Combinable with
 EM 500 G3	SK 500 G3 	<ul style="list-style-type: none"> • Clip-on microphones: ME 2, ME 4, MKE 2, MKE 40 • Headmics: ME 3, HSP 2, HSP 4 • Instrument cable: CI 1
	SKM 500 G3 	Interchangeable microphone heads: <ul style="list-style-type: none"> • MMD 835-1, MMD 845-1 • MMD 935-1, MMD 945-1 • MME 865-1, MMK 965-1

The devices are available in the same UHF frequency ranges and are equipped with the same frequency bank system with factory-preset frequencies. An advantage of the factory-preset frequencies is that

- a transmission system is ready for immediate use after switch-on,
- several transmission systems can be operated simultaneously on the preset frequencies without causing intermodulation interference.

The frequency bank system

The receiver is available in 6 UHF frequency ranges with 1,680 frequencies per frequency range:

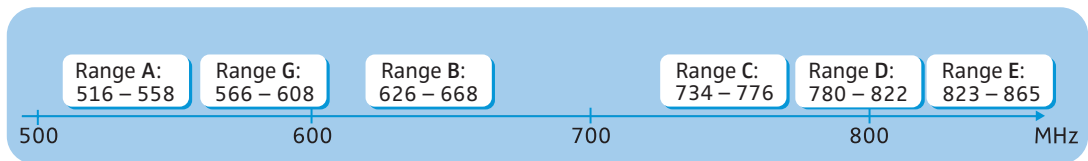

Each frequency range (A–E, G) offers 26 frequency banks with up to 32 channels each:

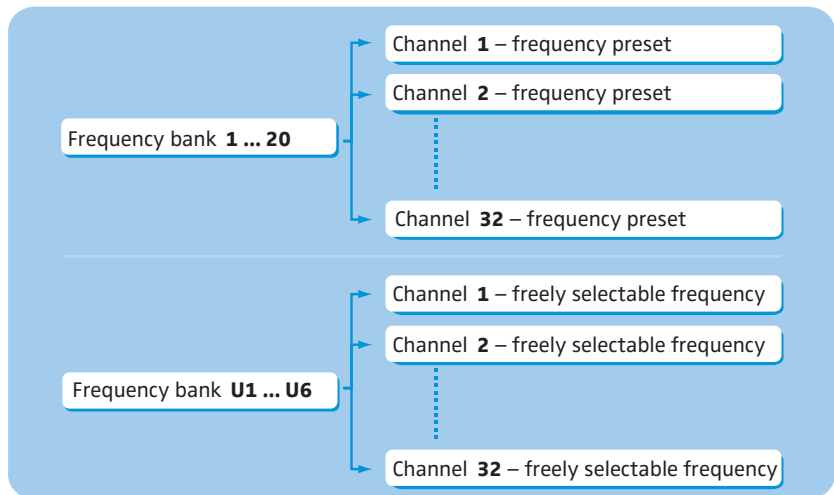

Each of the channels in the frequency banks “1” to “20” has been factory-preset to a fixed frequency (frequency preset).

The factory-preset frequencies within one frequency bank are intermodulation-free. These frequencies cannot be changed.

For an overview of the frequency presets, please refer to the supplied frequency information sheet. Updated versions of the frequency information sheet can be downloaded from the EM 500 G3 product page on our website at www.sennheiser.com.

The frequency banks “U1” to “U6” allow you to freely select and store frequencies. It might be that these frequencies are **not** intermodulation-free (see page 47).

Delivery includes

The packaging contains the following items:

- 1 EM 500 G3 rack-mount receiver
- 1 NT 2-3 mains unit with one country adapter
- 2 rod antennas
- 1 GA 3 rack adapter
- 1 instruction manual
- 1 frequency information sheet
- 4 device feet

Product overview

Overview of the EM 500 G3 receiver

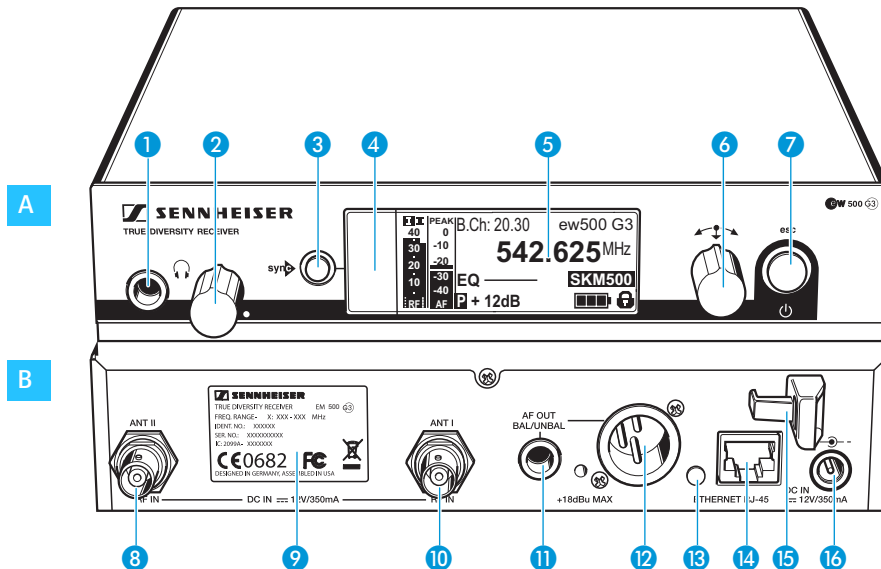

A Operating elements – front panel

- 1 Headphone output, 1/4" (6.3 mm) jack socket (🎧)
- 2 Headphone volume control
- 3 **syn** button, backlit
- 4 Infra-red interface
- 5 Display panel, backlit in orange
- 6 Jog dial
- 7 **STANDBY** button with operation indication (red back-lighting); ESC function (cancel)

B Operating elements – rear panel



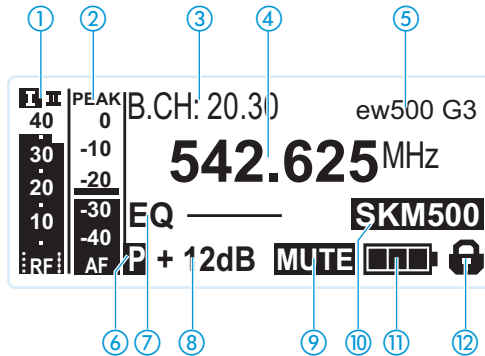

- 8 Antenna input II (**ANT II**) with remote power supply input, BNC socket
- 9 Type plate
- 10 Antenna input I (**ANT I**) with remote power supply input, BNC socket
- 11 Audio output (**AF OUT UNBAL**), 1/4" (6.3 mm) jack socket, unbalanced
- 12 Audio output (**AF OUT BAL**), XLR-3M socket, balanced
- 13 LED (yellow) for network activity indication
- 14 LAN socket (**ETHERNET RJ 45**)
- 15 Cable grip for power supply DC cable
- 16 DC socket (**DC IN**) for connection of NT 2-3 mains unit

Overview of the displays

After switch-on, the receiver displays the standard display “Receiver Parameters”. For further illustrations and examples of the different standard displays, please refer to page 25. This standard display displays the operating states of the receiver and provides the most important information on the received transmitter – provided the transmitter supports this function.



Display	Transmitter/ receiver	Meaning
① RF level “RF” (Radio Frequency)	Receiver	<p>Diversity display:</p> <ul style="list-style-type: none"> I I Antenna input I is active I I Antenna input II is active <p>RF signal level: Field strength of the received signal</p> <p>Squelch threshold level</p>
② Audio level “AF” (Audio Frequency, see page 37)	Transmitter	<p>Modulation of the transmitter with peak hold function</p> <p>When the display for audio level shows full deflection, the audio level is excessively high. When the transmitter is overmodulated frequently or for extended periods of time, the “PEAK” display is shown inverted.</p>
③ Frequency bank and channel (see page 36)	Receiver	Current frequency bank and channel number

Display	Transmitter/ receiver	Meaning
④ Frequency (see page 36)	Receiver	Current receiving frequency
⑤ Name (see page 37)	Receiver	Freely selectable name of the receiver
⑥ Pilot tone "P" (see page 42)	Receiver	Activated pilot tone evaluation
⑦ Equalizer setting (see page 38)	Receiver	Current equalizer setting
⑧ Output gain (see page 37)	Receiver	Current output gain of the audio signal available at the 1/4" (6.3 mm) jack socket ⑪ / XLR-3M socket ⑫
⑨ Muting function "MUTE" (see page 24)	Receiver/ transmitter	Audio signal is muted (see also page 51)
⑩ Transmitter type	Transmitter	Product name of the linked ew G3 transmitter The product name is displayed only if the transmitter supports this function.
⑪ Battery status	Transmitter	<p>Charge status:</p> <ul style="list-style-type: none">  approx. 100%  approx. 70%  approx. 30%  battery icon is flashing; charge status is critical <p>When the charge status is critical, "Low Battery" appears on the standard display.</p>
⑫ Lock mode icon (see page 38)	Receiver	Lock mode is activated

Putting the receiver into operation

Preparing the receiver for use



Recommendations for optimum reception

To ensure optimum reception even under difficult conditions, we recommend connecting remote antennas and, if necessary, using antenna splitters (see "Accessories and spare parts" on page 53).

When rack-mounting the receiver, you can mount the supplied antennas to the front of the rack by using an antenna front mount kit. When mounting more than one receiver into a rack, you should use remote antennas.

If you want to mount the receiver [into a 19" rack](#):

- ▶ Read the corresponding chapter on page 14.

If you want to set up the receiver [on a flat surface](#):

- ▶ Read the next chapter.

Setting up the receiver on a flat surface

CAUTION!

Risk of staining of furniture surfaces!

Some furniture surfaces have been treated with varnish, polish or synthetics which might cause stains when they come into contact with other synthetics. Despite a thorough testing of the synthetics used by us, we cannot rule out the possibility of staining.

- ▶ Do not place the receiver on delicate surfaces.

Mounting the rack mount "ears"



The rack mount "ears" are designed to help protect the operating elements from damage or deformation, e.g. if the receiver is dropped. Therefore, fasten the rack mount "ears", even if you do not want to rack mount your receiver.

To fasten the rack mount "ears" :

- ▶ Unscrew and remove the two recessed head screws (M4x8) on each side of the receiver (see left-hand diagram).

- ▶ Secure the rack mount "ears" 20 to the sides of the receiver using the previously removed recessed head screws (see right-hand diagram).

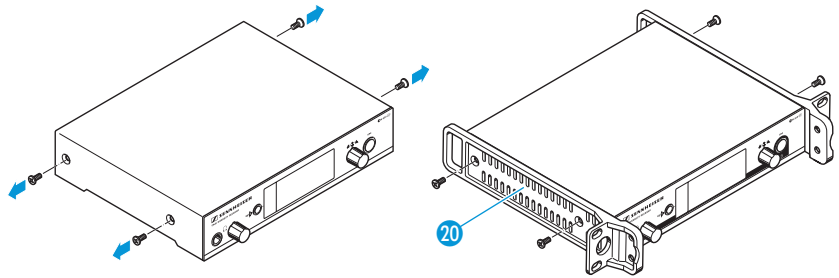

Fitting the device feet



Do not fit the device feet when mounting the receiver into a 19" rack.



- ▶ Clean the base of the receiver where you want to fix the device feet.
- ▶ Fit the device feet to the four corners of the receiver as shown.
- ▶ Place the receiver on a flat, horizontal surface.

Connecting the rod antennas

The supplied rod antennas 17 can be mounted quickly and easily and are suitable for all applications where – good reception conditions provided – a wireless transmission system is to be used without a large amount of installation work.

- ▶ Connect the two rod antennas 17 to the BNC sockets 8 and 10 at the rear of the receiver.

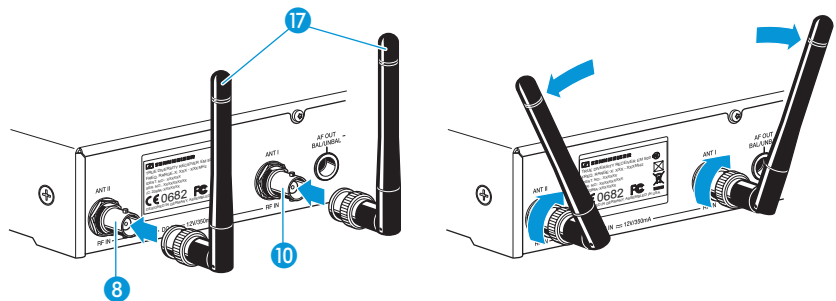

- ▶ Align the rod antennas upwards in a V-shape.



When using more than one receiver, we recommend connecting remote antennas and, if necessary, using Sennheiser antenna accessories. For more information, visit the ew G3 product page at www.sennheiser.com.

Mounting the receiver into a 19" rack



Do not fit the device feet when mounting the receiver into a 19" rack.

CAUTION!



Risks when rack mounting the receiver!

When installing the device in a closed or multi-rack assembly, please consider that, during operation, the ambient temperature, the mechanical loading and the electrical potentials will be different from those of devices which are not mounted into a rack.

- ▶ Make sure that the ambient temperature within the rack does not exceed the permissible temperature limit specified in the specifications (see page 55).
- ▶ Ensure sufficient ventilation; if necessary, provide additional ventilation.
- ▶ Make sure that the mechanical loading of the rack is even.
- ▶ When connecting to the power supply, observe the information indicated on the type plate. Avoid circuit overloading. If necessary, provide overcurrent protection.
- ▶ When rack mounting, please note that intrinsically harmless leakage currents of the individual mains units may accumulate, thereby exceeding the allowable limit value. As a remedy, ground the rack via an additional ground connection.

Rack mounting one receiver

- ▶ Secure the rack mount "ears" 20 of the supplied GA 3 rack adapter to the receiver as described on page 12.
- ▶ Secure the blanking plate 21 of the supplied GA 3 rack adapter to one of the rack mount "ears" 20 using two recessed head screws (M 6x10).

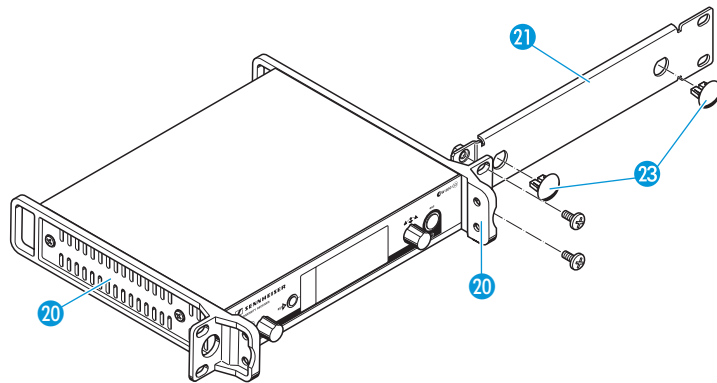

- ▶ Connect the antennas. You have the following options:
 - You can connect the supplied rod antennas 17 to the rear of the receiver (see page 13). In this case, insert the two blanking plugs 23 into the holes of the blanking plate (see diagram above).
 - You can use the AM 2 antenna front mount kit (see “Accessories and spare parts” on page 53) and mount the rod antennas to the blanking plate 21 (see diagram below).

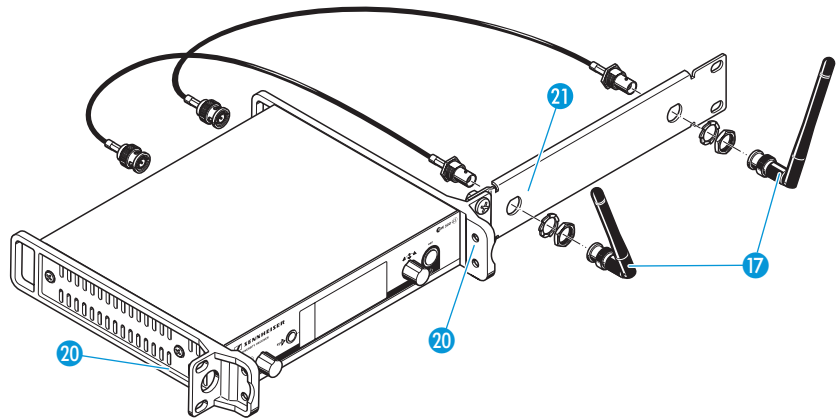

When using more than one receiver, we recommend connecting remote antennas and, if necessary, using Sennheiser antenna accessories. For more information, visit the ew G3 product page at www.sennheiser.com.

To mount the receiver into a 19" rack:

- ▶ Slide the receiver with the mounted blanking plate 21 into the 19" rack.
- ▶ Secure the rack mount "ears" 20 to the 19" rack.

If you are using the supplied rod antennas:

- ▶ Align the antennas in a V-shape to obtain the best possible reception.

Rack mounting two receivers



When rack mounting two receivers side by side, you can only front mount the antennas when using the ASA 1 antenna splitter in conjunction with the AM 2 antenna front mount kit and an additional GA 3 rack adapter (see "Accessories and spare parts" on page 53).

We recommend using remote antennas.

To mount the receivers into a rack using the GA 3 rack adapter:

- ▶ Place the two receivers side by side upside-down onto a flat surface.

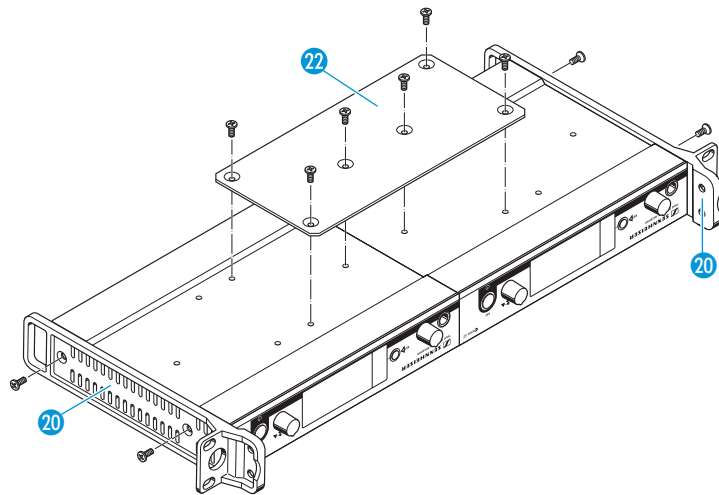

- ▶ Secure the joining plate 22 to the receivers using six recessed head screws (M 3x6).
- ▶ Secure the rack mount "ears" 20 to the receivers as described on page 12.

To mount the antennas:

- ▶ Use remote antennas, if necessary in conjunction with the ASA 1 antenna splitter (see “Accessories and spare parts” on page 53).

To mount the receivers into the rack:

- ▶ Slide the receivers into the 19” rack.
- ▶ Secure the rack mount “ears” to the 19” rack.

Connecting an amplifier/mixing console

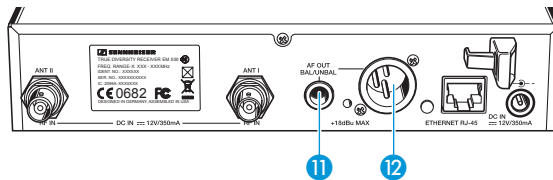

The receiver’s 1/4” (6.3 mm) jack socket 11 and XLR-3M socket 12 are connected in parallel, allowing you to simultaneously connect two devices (e.g. amplifier, mixing console) to the receiver.

- ▶ Use a suitable cable to connect the amplifier/mixing console to the 1/4” (6.3 mm) jack socket 11 or the XLR-3M socket 12.



For detailed information on balanced and unbalanced connection, please refer to the chapter “Connector assignment” on page 57.

Connecting receivers in a network

You can connect several receivers in a network. The receivers are remote controlled via a PC running the “Wireless Systems Manager” (WSM) software. This software will assist in the quick and safe configuration of multi-channel systems.

For further information on downloading the software, visit the ew G3 product page on our website at www.sennheiser.com.

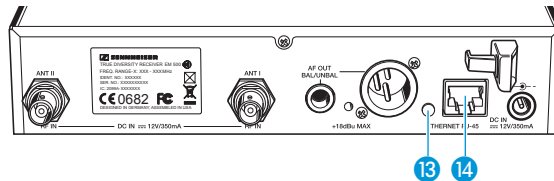

- ▶ Connect a standard network cable (at least Cat 5) to the LAN socket **14** of the receiver.
- ▶ Connect your receivers to an Ethernet switch.
- ▶ Additionally, connect a PC to the Ethernet switch as shown.

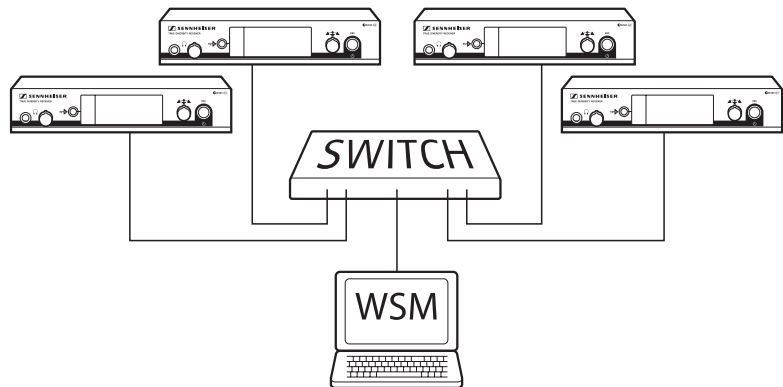

- ▶ Set up your multi-channel system as described on page 46.



The yellow LED **13** at the rear of the receiver indicates the network activity:

Yellow LED ...	Connection status
... lit	Network cable connected to the Ethernet switch or PC
... off	No connection

Connecting the mains unit

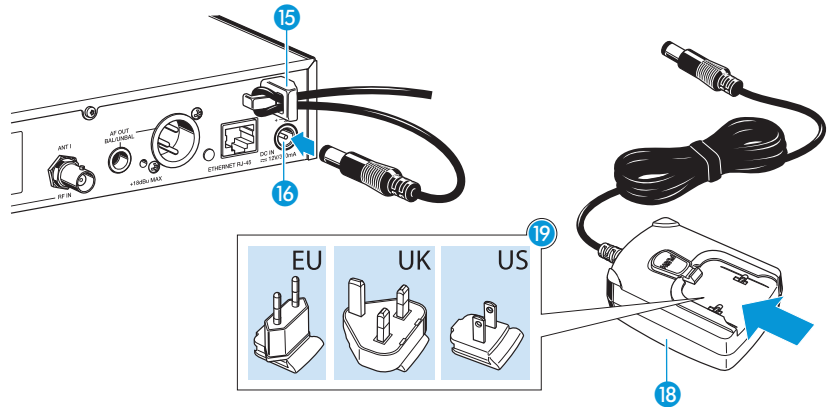

Only use the supplied NT 2-3 mains unit. It is designed for your receiver and ensures safe operation.

To connect the NT 2-3 mains unit:

- ▶ Connect the yellow connector of the mains unit **18** to the yellow socket **16** at the rear of the receiver.
- ▶ Pass the cable of the mains unit through the cable grip **15**.
- ▶ Slide the supplied country adapter **19** onto the mains unit **18**.
- ▶ Plug the mains unit **18** into a wall socket.
The **STANDBY** button **7** is backlit in red.

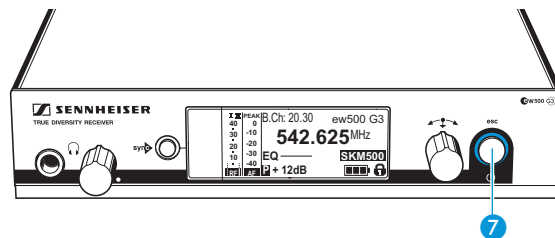

Using the receiver

To establish a transmission link, proceed as follows:

1. Switch the receiver on (see next section).
2. Switch the transmitter on (see the instruction manual of the transmitter).
The transmission link is established and the display backlighting of the receiver changes from red to orange.



It is vital to observe the notes on frequency selection on page 45.

If you cannot establish a transmission link between transmitter and receiver:

- ▶ Make sure that transmitter and receiver are set to the same frequency bank and to the same channel.
- ▶ Read the chapter “Synchronizing transmitters with receivers” on page 45 and, if necessary, the chapter “If a problem occurs ...” on page 51.

Switching the receiver on/off

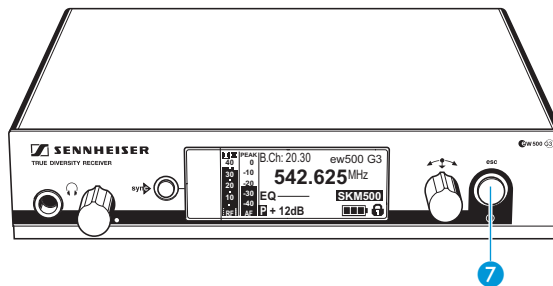

To switch the receiver **on**:

- ▶ Briefly press the **STANDBY** button **7**.
The receiver switches on and the “**Receiver Parameters**” standard display appears.

- ▶ To switch the receiver to **standby mode**:

- ▶ Keep the **STANDBY** button 7 pressed until "OFF" appears on the display panel.
The receiver switches to standby mode.

 When in the operating menu, pressing the **STANDBY** button 7 will cancel your entry (ESC function) and return you to the current standard display.

The **STANDBY** button 7 is backlit in red both during operation and in standby mode.

To completely switch the receiver off:

- ▶ Disconnect the receiver from the mains by unplugging the mains unit from the wall socket.
The backlighting of the **STANDBY** button 7 goes off.

Monitoring the audio signal via headphones

CAUTION!



Danger of hearing damage!

Listening at high volume levels for long periods can lead to permanent hearing defects.

- ▶ Set the headphone volume control 2 to the minimum position before putting the headphones on.

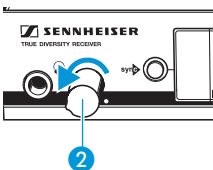
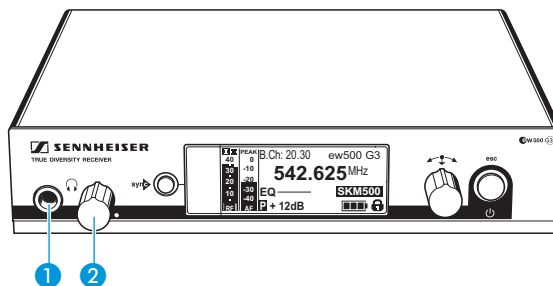

- ▶ Set the headphone volume control 2 to the minimum position.
- ▶ Connect headphones with a 1/4" (6.3 mm) stereo jack plug to the headphone output 1.
- ▶ Gradually increase the volume and monitor the audio signal with the lowest possible volume.

sync Synchronizing a transmitter with the receiver

You can synchronize a suitable transmitter of the ew 500 G3 series with the receiver. If the receiver is in ex works condition, the following parameters are transferred to the transmitter during synchronization:

Setting	Transferred parameters
"Frequency Preset"	Currently set frequency
"Name"	Freely selectable name currently set on the receiver
"Pilot Tone"	Current pilot tone setting of the receiver ("Inactive"/"Active")



Via the "Sync Settings" submenu, you can adjust the parameters to be transferred to your transmitters (see page 41). It is vital to observe the notes on frequency selection on page 45.

To transfer the parameters:

- ▶ Switch the transmitter and the receiver on.

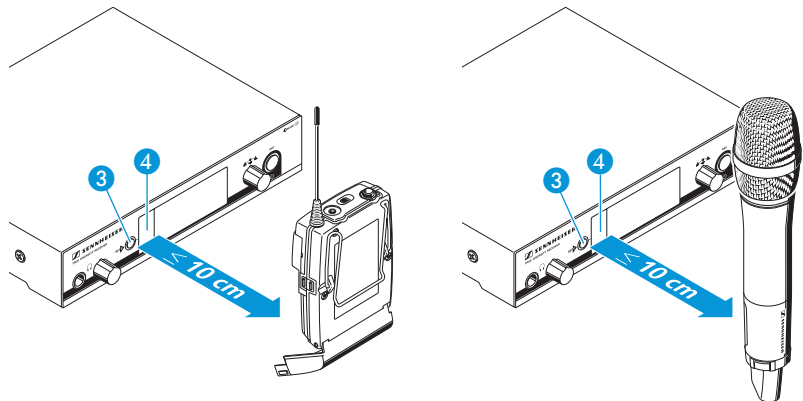

- ▶ Press the **sync** button **3** on the receiver. "Sync" appears on the display panel of the receiver.
- ▶ Place the infra-red interface of the transmitter (see the instruction manual of the transmitter) in front of the infra-red interface **4** of the receiver.
The parameters are transferred to the transmitter. When the transfer is completed, "✓" appears on the receiver's display panel. The receiver then switches back to the current standard display.

To cancel the transfer:

- ▶ Press the **STANDBY** button **7** on the receiver.
 “X” appears on the display panel of the receiver. “X” also appears if no suitable transmitter was found.

Deactivating the lock mode temporarily

You can activate or deactivate the automatic lock mode via the “Auto Lock” menu item (see page 38).

If the lock mode is activated, you have to temporarily deactivate it in order to be able to operate the receiver:



- ▶ Press the jog dial.
 “Locked” appears on the display panel.



- ▶ Turn the jog dial.
 “Unlock?” appears on the display panel.



- ▶ Press the jog dial.
 The lock mode is temporarily deactivated:

When you are in the operating menu

The lock mode remains deactivated until you exit the operating menu.

When one of the standard displays is shown

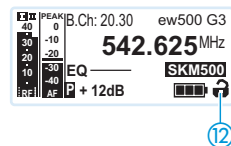

The lock mode is automatically activated after 10 seconds.

The lock mode icon **12** flashes prior to the lock mode being activated again.





Muting the audio signal

To **mute** the audio signal:

-  ▶ When one of the standard displays is shown on the display panel, press the **STANDBY** button.
“RX Mute On?” appears on the display panel.
-  ▶ Press the jog dial.
The audio signal is muted. “RX Mute” flashes in alternation with the current standard display. The display panel is backlit in red.

To **unmute** the audio signal:

-  ▶ Press the **STANDBY** button.
“RX Mute Off?” appears on the display panel.
-  ▶ Press the jog dial.
The muting is canceled and the display backlighting changes from red to orange again.

If “RX Mute On?” or “RX Mute Off?” appears on the display panel but you do not wish to change the status of the muting function:

-  ▶ Press the **STANDBY** button.
The status of the muting function remains unchanged and the current standard display appears.

Selecting a standard display

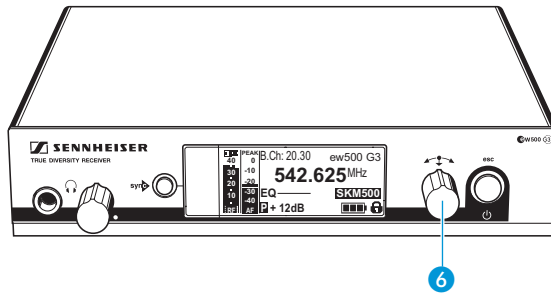

▶ Turn the jog dial to select the standard display:



Contents of the display	Selectable standard display
	<p>“Transmitter Parameters”* (transmitter type/microphone, inverted display) displays the microphone head (SKM only) and the transmitter type</p>
	<p>“Receiver Parameters” appears after switch-on of the receiver and displays the receiver parameters (see page 10)</p>
	<p>“Soundcheck” (display with additional function) displays the signal quality within the transmission area (see page 31)</p>
	<p>“Guitar Tuner”** (display with additional function) displays the guitar tuner (see page 31)</p>

- * The reading of the transmitter parameters can take up to 2 minutes. If you synchronize your transmitter with the receiver (see page 22), the parameters are read out without delay.
- **The **“Guitar Tuner”** standard display is deactivated upon delivery. To show this standard display, you have to activate it (see page 40).

Using the operating menu

A special feature of the Sennheiser ew G3 series is the consistent, intuitive menu structure of transmitters and receivers. As a result, adjustments to the settings can be made quickly – even in stressful situations, for example on stage or during a live show or presentation.

The buttons

Button	Function of the button
Press the STANDBY button 	<ul style="list-style-type: none"> • Switches the receiver on and off • Cancels the entry and returns to the current standard display (ESC function) • Mutes the receiver (special function, see page 24)
Press the jog dial 	<ul style="list-style-type: none"> • Changes from the current standard display to the operating menu • Calls up a menu item • Enters a submenu • Stores the settings and returns to the operating menu
Turn the jog dial 	<ul style="list-style-type: none"> • Selects a standard display (see page 25) • Changes to the next/previous menu item • Changes the setting of a menu item

Overview of the operating menu

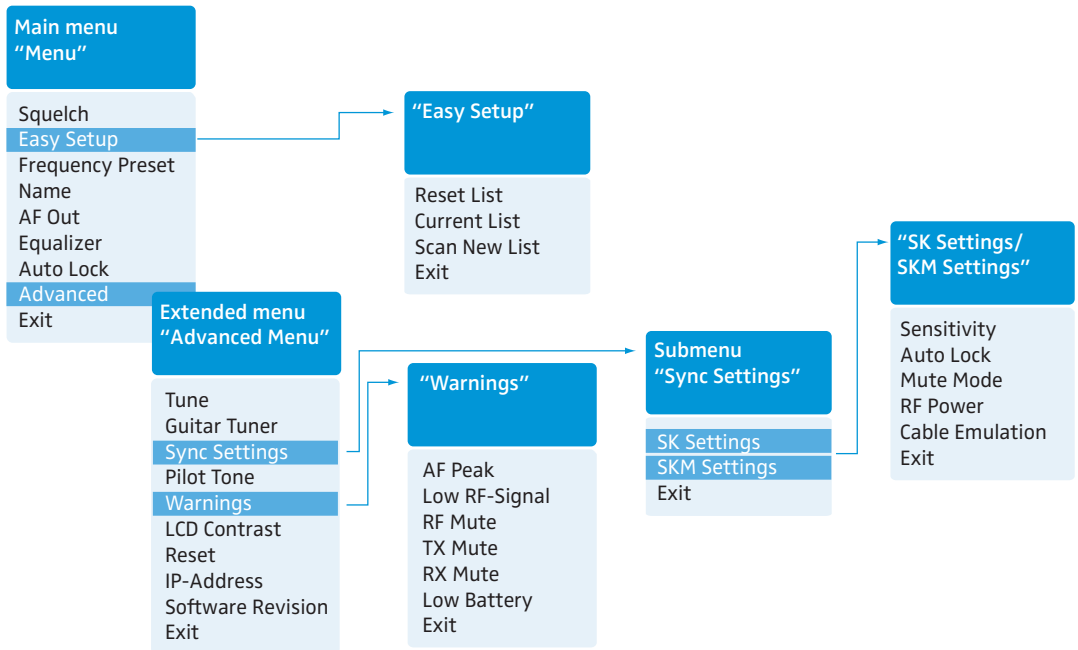

Display	Function of the menu item	Page
Main menu "Menu"		
Squelch	Adjusts the squelch threshold	34
Easy Setup	Scans for unused frequency presets, releases and selects frequency presets	35
Frequency Preset	Sets the frequency bank and the channel	36
Name	Enters a freely selectable name	37
AF Out	Adjusts the audio output level	37
Equalizer	Changes the frequency response of the output signal	38
Auto Lock	Activates/deactivates the automatic lock mode	38
Advanced	Calls up the extended menu "Advanced Menu"	39
Exit	Exits the operating menu and returns to the current standard display	-

Display	Function of the menu item	Page
“Easy Setup”		
Reset List	Releases all locked frequency presets	35
Current List	Selects an unused frequency preset	
Scan New List	Scans for unused receiving frequencies (frequency preset scan)	
Exit	Exits “Easy Setup” and returns to the main menu	
Extended menu “Advanced Menu”		
Tune	Sets the receiving frequencies for the frequency banks “U1” to “U6”	39
	Sets the frequency bank, the channel and the transmission frequency (frequency banks “U1” to “U6”)	40
Guitar Tuner	Selects the mode of the guitar tuner function	40
Sync Settings	Calls up the “Sync Settings” submenu: Adjusts the parameters to be transferred to the transmitters and activates/deactivates the transfer (see below)	41
Pilot Tone	Activates/deactivates the pilot tone evaluation	42
Warnings	Calls up “Warnings”: Activates/deactivates warnings (color change and warning messages)	43
LCD Contrast	Adjusts the contrast of the display panel	43
Reset	Resets the settings made in the operating menu	44
IP-Address	Adjusts the IP address of the receiver	44
Software Revision	Displays the current software revision	44
Exit	Exits the extended menu “Advanced Menu” and returns to the main menu	-
“Sync Settings”		
SK Settings	Adjusts the parameters to be transferred to the SK transmitters and activates/deactivates the transfer	41
SKM Settings	Adjusts the parameters to be transferred to the SKM radio microphone and activates/deactivates the transfer	
Exit	Exits the “Sync Settings” submenu and returns to the extended menu “Advanced Menu”	-

Working with the operating menu



If the lock mode is activated, you have to deactivate it in order to be able to work with the operating menu (see page 23).

By way of example of the “Frequency Preset” menu item, this section describes how to use the operating menu.

Changing from a standard display to the operating menu



- ▶ Press the jog dial.
The current standard display is replaced by the main menu.
The last selected menu item is displayed.

Menu
Squelch
Easy Setup
Frequency Preset
Name
AF Out
Equalizer
Auto Lock
Advanced
Exit

Selecting a menu item



- ▶ Turn the jog dial to change to the “Frequency Preset” menu item.
The current setting of the menu item is displayed:

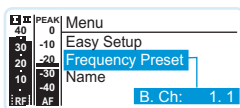

Changing and storing settings

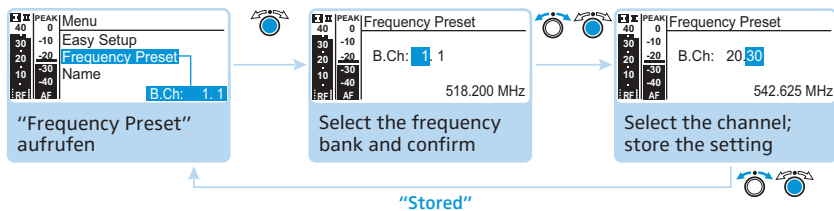

- ▶ Turn the jog dial to call up the menu item.



- ▶ Turn the jog dial to set the frequency bank.



- ▶ Press the jog dial to confirm your selection.



- ▶ Turn the jog dial to set the channel.



- ▶ Press the jog dial to store the setting.

Canceling an entry



-  ▶ Press the **STANDBY** button to cancel an entry.
The current standard display appears on the display panel.

To subsequently return to the last edited menu item:

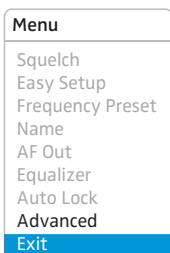
-  ▶ Press the jog dial switch repeatedly until the last edited menu item appears.



Exiting a menu item

-  ▶ Change to the "Exit" menu item.
-  ▶ Confirm your selection.
You return to the next higher menu level.

To directly return to the current standard display:

-  ▶ Press the **STANDBY** button.

Adjustment tips and functions

The operating menu allows you to make settings for your receiver and your transmitters. The “[Guitar Tuner](#)” and “[Soundcheck](#)” standard displays provide additional functions and can be called up by turning the jog dial, without having to get into the operating menu.

Standard displays with additional functions

Tuning a guitar (SK transmitters only)

- ▶ Activate the “[Guitar Tuner](#)” standard display via the operating menu (see page 40).
- ▶ Connect a guitar to your SK transmitter.
- ▶ On the receiver, change to the “[Guitar Tuner](#)” standard display (see page 25).

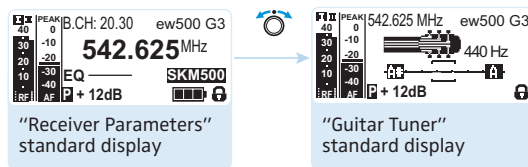

- ▶ Tune your guitar.
The receiver automatically recognizes the pitch of the plucked string.
For more information on the “[Guitar Tuner](#)” menu item, refer to page 40.

Doing a soundcheck

By doing a soundcheck, you can check the reception area for field strength gaps (“dropouts”) which cannot be compensated for by the receiver’s diversity circuitry.



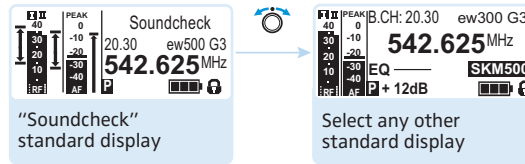

The “[Soundcheck](#)” standard display must not be activated until later because otherwise the recording will give wrong results.

- ▶ If necessary, change from the “[Soundcheck](#)” standard display to one of the other standard displays of your receiver.

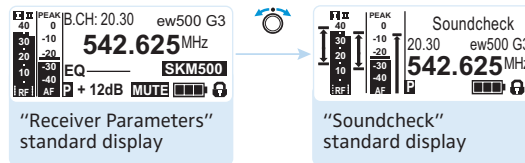

- ▶ Position the transmitter in the area in which it is to be used and switch it on.
- ▶ Leave the transmitter switched on and go to your receiver.
- ▶ On the receiver, change to the “Soundcheck” standard display.



 If no transmitter is being received or if the signal is below the squelch threshold level, “MUTE” appears on the display panel (see “If a problem occurs ...” on page 51).

- ▶ Go to your transmitter.
- ▶ With the transmitter, walk up and down the area in which it is to be used.
- ▶ Then leave the transmitter there and do **not** switch it off.

During the soundcheck, the receiver records the RF level and the AF level. The recording result is displayed on the “Soundcheck” standard display:

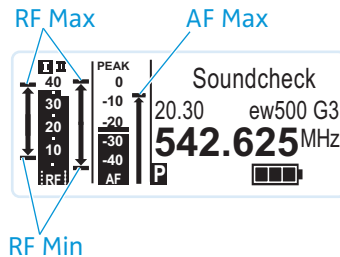

Display	Meaning	What to do ...
RF Min	Min. RF signal level: must be well above the squelch threshold level for one of the two antennas	<ul style="list-style-type: none"> ▶ Check if the antennas and the antenna cables are correctly connected. ▶ Improve the position of the antennas.
RF Max	Max. RF signal level: both antennas should reach 40 dB μ V	<ul style="list-style-type: none"> ▶ If necessary, use antenna boosters.
AF Max	Max. audio level	<ul style="list-style-type: none"> ▶ On your transmitter, adjust the audio level as high as possible without the level display for audio level showing full deflection (AF Max is at a level with the PEAK display). For more information, refer to the instruction manual of the transmitter.

If only one or none of the diversity displays is displayed during the sound check:

- ▶ Check if the antennas are properly positioned or check the antenna cables.



Both diversity displays can only be displayed on the “[Soundcheck](#)” standard display. During normal operation of the receiver, only one of the diversity displays is displayed.

The main menu “Menu”

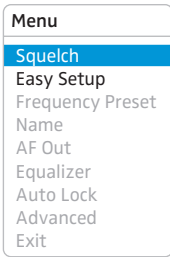

Adjusting the squelch threshold

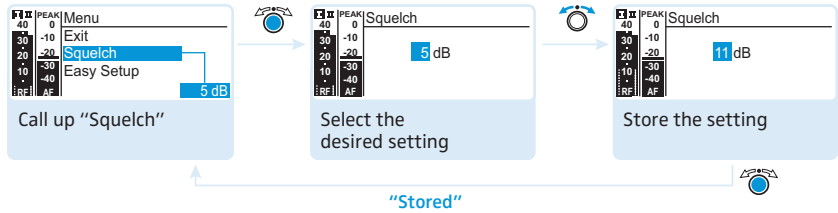

Adjustment range: 5 to 25 dB μ V, adjustable in 2-dB steps, can be switched off

The squelch eliminates annoying noise when the transmitter is switched off. It also suppresses sudden noise when there is no longer sufficient transmitter power received by the receiver.

- ▶ Adjust the squelch threshold – with the transmitter switched off – to the lowest possible setting that suppresses hissing noise.



If you adjust the squelch threshold to a high value, the transmission range will be reduced under adverse RF reception conditions.

CAUTION!



Danger of hearing damage and material damage!

If you switch the squelch off or adjust the squelch threshold to a very low value, loud hissing noise can occur in the receiver. The hissing noise can be loud enough to cause hearing damage or overload the loudspeakers of your system!

- ▶ Always make sure that the squelch is switched on (see below).
- ▶ Before adjusting the squelch threshold, set the volume of the headphone output (see page 21) and the audio output level (“AF Out”, see page 37) to the minimum.
- ▶ Never change the squelch threshold during a live transmission.

The squelch should only be switched off for servicing purposes. With the squelch threshold set to “5 dB”, you switch the squelch off by turning the jog dial to the left and keeping it in this position for 3 seconds.

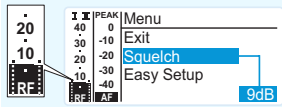
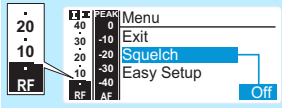
Display	Squelch is ...
	... switched on The dotted line displays the squelch threshold.
	... switched off. The dotted line goes off and the audio level display “AF” shows full deflection (hissing noise).

If you have accidentally switched off the squelch:

- ▶ Turn the jog dial to the right to switch the squelch on.

Scanning for, releasing and selecting frequency presets

Menu
Squelch
Easy Setup
Frequency Preset
Name
AF Out
Equalizer
Auto Lock
Advanced
Exit

Menu item	Function of the menu item
Scan New List	Automatically scans for unused receiving frequencies (frequency preset scan). If receiving frequencies are used, they will be locked; if receiving frequencies are unused, they will be released. After the frequency preset scan, you can select an unused frequency preset.
Reset List	Releases all locked frequency presets
Current List	Selects an unused frequency preset

If you call up the “Scan New List” menu item, your receiver scans for unused frequency presets. After the scan, the receiver displays a list of the frequency banks and their unused channels. The frequency bank with the largest number of unused channels is automatically selected.

To perform a frequency preset scan:

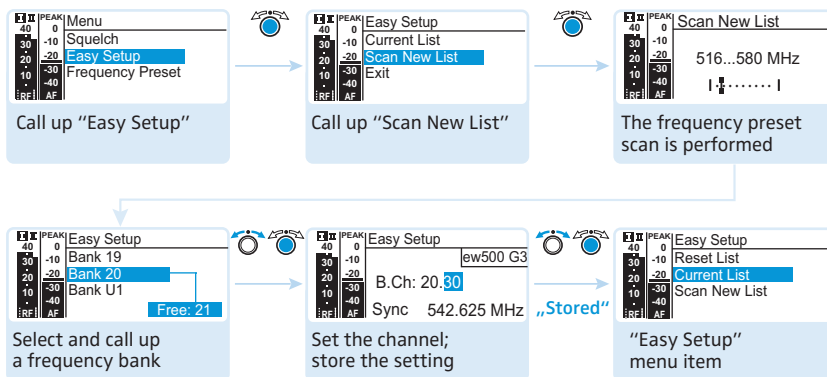

You can call up the list containing the frequency banks again by selecting the "Current List" menu item.

Menu
Squelch
Easy Setup
Frequency Preset
Name
AF Out
Equalizer
Auto Lock
Advanced
Exit

Selecting the frequency bank and the channel

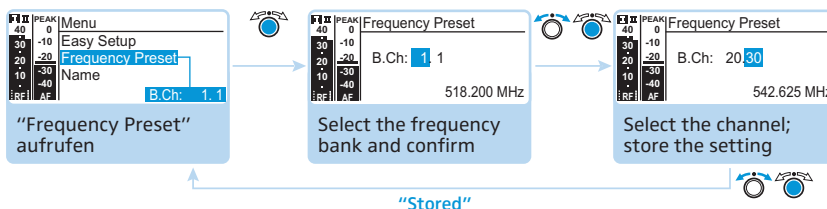

When setting up multi-channel systems, please observe the following:

Only the factory-preset frequencies within one frequency bank ("1" to "20") are intermodulation-free. It is vital to observe the notes on frequency selection on page 45.

Overview of the frequency banks and channels:

Frequency bank	Channels	Type
"1" to "20"	up to 32 per frequency bank	System bank: frequencies are factory-preset
"U1" to "U6"	up to 32 per frequency bank	User bank: frequencies are freely selectable

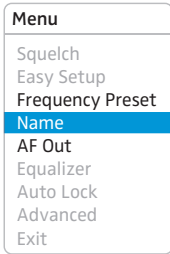

Entering a name

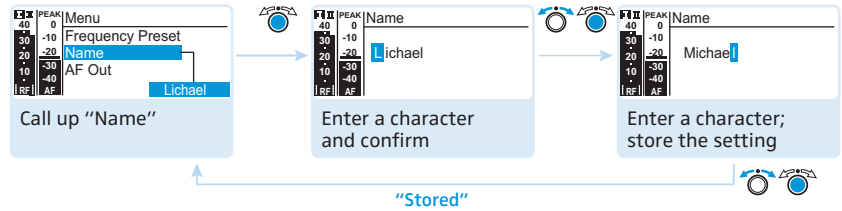

Via the “Name” menu item, you can enter a freely selectable name (e.g. the name of the performer) for the receiver.

The name is displayed on the “Receiver Parameters” standard display and can consist of up to eight characters such as:

- letters (without pronunciation marks),
- numbers from 0 to 9,
- special characters and spaces.

To enter a name, proceed as follows:



▶ Turn the jog dial to select a character.



▶ Press the jog dial to change to the next segment/character or to store the complete entry.

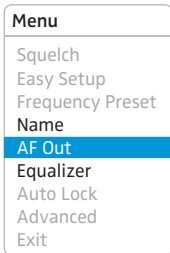

Adjusting the audio output level

Adjustment range: –24 dB to +24 dB, adjustable in 3-dB steps

Via the “AF Out” menu item, you can adjust the level of the audio output **AF OUT** from the receiver to the input of the connected device. The following figures are a guide to the best settings:

Connected device	Guide values for “AF Out”
Line	0 to +18 dB (+24 dB)
Microphone	–24 dB to –6 dB

Gain values greater than +18 dB should only be used when the audio modulation from the transmitter is at a low level, otherwise the audio output of the receiver may become clipped and distorted.





To adjust a gain greater than +18 dB (gain reserve):

- ▶ Adjust a level of +18 dB.
- ▶ Turn the jog dial to the right and hold it in this position for 3 seconds. The next higher value (+21 dB) appears. The audio output level is increased. Using this gain reserve also increases the headphone output level.

Menu
Squelch
Easy Setup
Frequency Preset
Name
AF Out
Equalizer
Auto Lock
Advanced
Exit

Using the equalizer

Via the “Equalizer” menu item, you can change the treble and bass of the audio output signal.

“Flat” (output signal remains unchanged)	“Low cut” (cuts the bass)	“Low Cut/ High Boost” (cuts the bass and boosts the treble)	“High Boost” (boosts the treble)
			

Menu
Squelch
Easy Setup
Frequency Preset
Name
AF Out
Equalizer
Auto Lock
Advanced
Exit

Activating/deactivating the automatic lock mode

The lock mode prevents that the receiver is accidentally switched off or programmed during operation.

The lock mode icon  on the current standard display indicates that the lock mode is activated. For information on how to use the lock mode, refer to page 23.

Menu
Squelch
Easy Setup
Frequency Preset
Name
AF Out
Equalizer
Auto Lock
Advanced
Exit

The extended menu “Advanced Menu”

To get into the extended menu “Advanced Menu”:

- ▶ From the main menu, select “Advanced”.

Advanced Menu
Tune
Guitar Tuner
Sync Settings
Pilot Tone
Warnings
LCD Contrast
Reset
IP-Address
Software Revision
Exit

Setting the receiving frequencies and the frequency banks “U1” to “U6



When you have selected one of the system banks and then select the “Tune” menu item, the receiver automatically switches to channel 1 of the frequency bank “U1”. In this case, “U1.1” briefly appears on the display panel.

Upon delivery, the channels of the frequency banks “U1” to “U6” are not assigned a receiving frequency.

Via the “Tune” menu item, you can set a receiving frequency to be stored in the current channel **or** you can select a different channel in one of the frequency banks “U1” to “U6” and assign this channel a receiving frequency.



It is vital to observe the notes on frequency selection on page 45.

Setting a receiving frequency for the current channel



- ▶ Turn the jog dial until the “Tune” menu item appears.



- ▶ Press the jog dial.
The frequency selection appears.

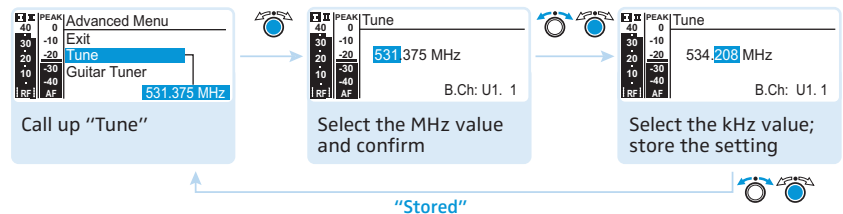

- ▶ Set the desired frequency.



- ▶ Press the jog dial.
Your settings are stored.
You are back to the operating menu.

Setting a frequency bank and a channel and assigning this channel a receiving frequency



▶ Turn the jog dial until the “Tune” menu item appears.



▶ Press the jog dial and keep it pressed until the frequency bank selection appears.

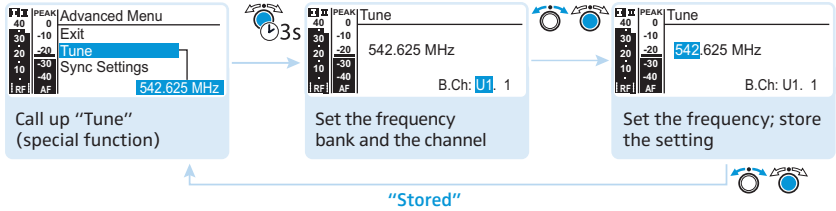

- ▶ Set the desired frequency bank.
- ▶ Press the jog dial. The channel selection appears.
- ▶ Set the desired channel.
- ▶ Press the jog dial. The frequency selection appears.
- ▶ Set the desired frequency.
- ▶ Press the jog dial. Your settings are stored. You are back to the operating menu.

Advanced Menu
Tune
Guitar Tuner
Sync Settings
Pilot Tone
Warnings
LCD Contrast
Reset
IP-Address
Software Revision
Exit

Changing the settings of the guitar tuner

The following settings are available:

Setting	Meaning
“Inactive”	The “Guitar Tuner” standard display is deactivated (see page 25).
“Active”	When selecting the “Guitar Tuner” standard display (see page 25), the receiver is not muted.
“Audio Mute”	When selecting the “Guitar Tuner” standard display (see page 25), the receiver is muted.

Advanced Menu
Tune
Guitar Tuner
Sync Settings
Pilot Tone
Warnings
LCD Contrast
Reset
IP-Address
Software Revision
Exit

“Sync Settings”

Via the “SK Settings” and “SKM Settings” menu items, you can set the transmitter parameters directly on the receiver and activate or deactivate the transfer of these parameters to the transmitter:

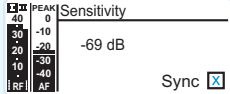
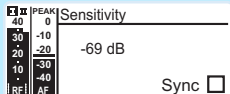
Setting	Transfer is...
	... activated
	... deactivated

By pressing the **sync** button **3**, you can transfer the parameters to the transmitters via the infra-red interface (see page 22).

Display	Function	Settings/ adjustment range
Sensitivity	Adjusts the input sensitivity:	
	SKM	-48 dB to 0 dB, adjustable in steps of 6 dB
	SK	-60 dB to 0 dB, adjustable in steps of 3 dB
Auto Lock	Activates/deactivates the lock mode	“Inactive”, “Active”
RF Power	Adjusts the transmission power	“Standard”, “Low”
Mute Mode	Sets the mode for the MUTE switch (SK only)	“Disabled”, “RF On/Off”, “AF On/Off”

- Advanced Menu
- Tune
- Guitar Tuner
- Sync Settings
- Pilot Tone**
- Warnings
- LCD Contrast
- Reset
- IP-Address
- Software Revision
- Exit

Activating/deactivating the pilot tone evaluation

The pilot tone supports the receiver's squelch function and protects against interference due to RF signals from other devices.

The transmitter adds an inaudible signal, known as the pilot tone, to the transmitted signal. The receiver detects and evaluates the pilot tone.

Receiver display	Meaning
	The pilot tone evaluation ⑥ is deactivated.
	The pilot tone evaluation ⑥ is activated.
	The pilot tone evaluation ⑥ is activated and the receiver receives a pilot tone from a transmitter.

Devices of the ew 500 G1 series (generation 1) do not support the pilot tone function. Therefore, please observe the following when combining a radio microphone or receiver of the ew 500 G3 series (generation 3) with devices from an earlier evolution wireless generation:







Transmitter	Receiver	Make sure to ...
ew G3/ew G2	ew G3/ew G2	... activate the pilot tone function on both transmitter and receiver.
ew G3	ew G1	... deactivate the pilot tone function on the ew 500 G3 transmitter.

Transmitter	Receiver	Make sure to ...
ew G1	ew G3	... deactivate the pilot tone function on the ew 500 G3 receiver.

Advanced Menu
Tune
Guitar Tuner
Sync Settings
Pilot Tone
Warnings
LCD Contrast
Reset
IP-Address
Software Revision
Exit

Activating/deactivating warnings

Via the "Warnings" menu item, you can activate or deactivate different warning messages.

Setting	Warning message with color change on the current standard display	Trigger
"AF PEAK"	 AF PEAK	Audio overmodulation
"Low RF Signal"	 Low RF Signal	RF signal is weak
"RF Mute"	 RF Mute	RF signal is too weak or no RF signal
"TX Mute"	 TX Mute	Transmitter is muted or no pilot tone
"RX Mute"	 RX Mute	Receiver is muted
"Low Battery"	 Low Battery	Charge status of the transmitter battery/the BA 2015 accupack is critical

Advanced Menu
Tune
Guitar Tuner
Sync Settings
Pilot Tone
Warnings
LCD Contrast
Reset
IP-Address
Software Revision
Exit

Adjusting the contrast of the display panel

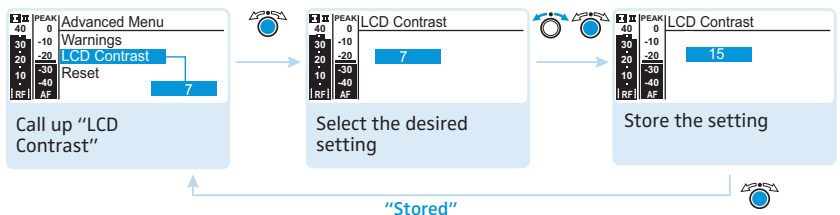

You can adjust the contrast of the display panel in 16 steps.

Resetting the settings made in the operating menu

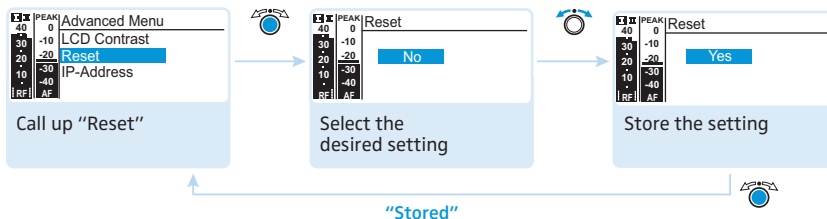
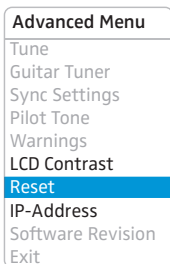

When resetting the settings made in the operating menu, only the selected settings for the pilot tone and for the frequency banks "U1" to "U6" remain unchanged. For an overview of the factory-preset default settings, refer to the supplied frequency information sheet.

Adjusting the network configuration

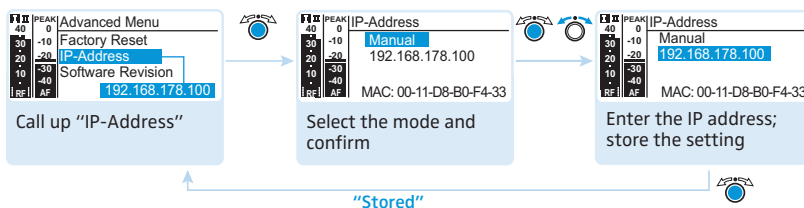
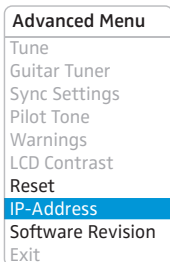

You can either automatically allocate or manually enter an IP address. This menu item also shows the receiver's unique and unchangeable MAC address.

In order to ensure safe communication between receivers in multi-channel systems (see page 46), we recommend using automatic allocation of IP addresses.

Displaying the software revision

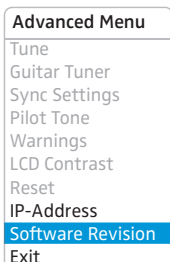

You can display the current software revision of the receiver.

- ▶ For information on software updates, visit the EM 500 G3 product page on our website at www.sennheiser.com.

Synchronizing transmitters with receivers

When synchronizing a transmitter with a receiver, please observe the following:



- ▶ Only use a transmitter and a receiver from the same frequency range (see the type plate on the transmitter and the receiver).
- ▶ Make sure that the desired frequencies are listed in the enclosed frequency information sheet.
- ▶ Make sure that the desired frequencies are approved and legal in your country and, if necessary, apply for an operating license.

Synchronizing a transmitter with the receiver – individual operation

Upon delivery, transmitter and receiver are synchronized with each other.

If, however, you cannot establish a transmission link between transmitter and receiver, you have to synchronize the channels of the devices:

- ▶ With the receiver, perform a frequency preset scan to scan the frequency banks for unused channels (“Scan New List”, see page 35). Then “Sync” appears on the display panel of the receiver.

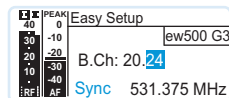

- ▶ Synchronize a transmitter with the receiver via the infra-red interface (see page 22). This establishes a transmission link between the transmitter and the receiver.

Alternatively, you can set the channel on the transmitter manually:

- ▶ Make sure that you set the transmitter to the same frequency bank and the same channel as the receiver (see the instruction manual of the transmitter).

Synchronizing transmitters with receivers – multi-channel operation



In order to ensure an intermodulation-free transmission, use the same frequency bank for all transmission links.

Network operation

Combined with ew 500 G3 transmitters, ew 500 G3 receivers can form transmission links that can be used in multi-channel systems.

In multi-channel operation, the receivers are remote controlled via a PC running the “Wireless Systems Manager” (WSM) software.

For further information on downloading the software, visit the ew G3 product page on our website at www.sennheiser.com.

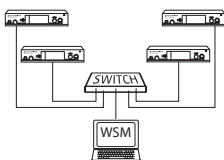

Advantages of controlling the receivers via the “Wireless Systems Manager” (WSM) software:

- Detailed overview of all receiving channels
- Remote control of all receivers in the network
- Combination of receivers of different frequency ranges (see page 6).

- ▶ Connect the receivers in a network (see page 18).
- ▶ Launch the “Wireless Systems Manager” (WSM) software).
- ▶ To scan for unused receiving frequencies and to configure the receivers, proceed as described in the instruction manual of the “Wireless Systems Manager” (WSM) software.
- ▶ Set the corresponding transmitter to the selected frequency bank and to the selected channel either by synchronizing the transmitter with the receiver (see page 22) or by setting the frequency bank and the channel manually (see the instruction manual of the transmitter). Your multi-channel system is now set up.

Operation without network

If you want to set up a multi-channel system without using the WSM, proceed as follows:

- ▶ Switch off all transmitters of your system that are to be automatically configured. Channels used by switched-on transmitters are displayed as “used”.

- ▶ With one of the receivers, perform a frequency preset scan to scan the frequency banks for unused channels (“Scan New List”, see page 35). Then “Sync” appears on the display panel of the receiver.

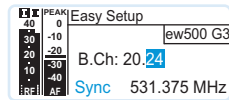

- ▶ Switch one of the transmitters on.
- ▶ Synchronize this transmitter with the receiver via the infra-red interface (see page 22). This establishes a transmission link between the transmitter and the receiver.
- ▶ Repeat for the remaining transmitter and receiver pairs as described above. Leave those transmitters switched on that are already linked to a receiver. Your multi-channel system is now set up.

Alternatively, you can set the channel on the transmitter manually:

- ▶ Make sure that you set the transmitter to the same frequency bank and the same channel as the receiver. For information on the setting options of the transmitter, refer to the instruction manual of the transmitter.

You can also freely select the receiving frequencies and store these frequencies in the frequency banks “U1” to “U6”.



If you are using frequencies from the frequency banks “U1” to “U6”, it might be that the receiving frequencies are not intermodulation-free.

To ensure that the desired frequencies are intermodulation-free:

- ▶ Contact your Sennheiser partner (see www.sennheiser.com).

If you want to use the frequency banks “U1” to “U6”:

- ▶ Make sure to use receivers from the same frequency range (see page 6 and the type plates of the devices).
- ▶ Only use frequencies that are approved and legal in your country.
- ▶ Set each receiver to the same frequency bank (see page 39).

- ▶ On one of the receivers, select a channel within this frequency bank (see page 39).
 - ▶ Assign this channel one of the receiving frequencies (see page 39).
 - ▶ Synchronize a transmitter with the receiver (see page 22).
- OR
- ▶ Manually set the transmitter to the same frequency bank, channel and frequency that you set on the receiver.
 - ▶ Repeat for the remaining transmitters and receivers as described above.

Cleaning the receiver

CAUTION!

Liquids can damage the electronics of the receiver!

Liquids entering the housing of the receiver can cause a short-circuit and damage the electronics.

- ▶ Keep all liquids away from the receiver.
-
- ▶ Before cleaning, disconnect the receiver from the mains.
 - ▶ Use a cloth to clean the receiver from time to time. Do not use any solvents or cleansing agents.

Recommendations and tips

... for optimum reception

- Transmission range depends to a large extent on location and can vary from about 10 m to about 150 m. There should be a “free line of sight” between transmitting and receiving antennas.
- If, with the EM 500 G3 receiver, reception conditions are unfavourable, you should use two remote antennas which are connected via antenna cable.
- To avoid overloading the receiver, observe a minimum distance of 5 m between transmitting and receiving antennas.
- Observe a minimum distance of 50 cm between receiving antennas and metal objects (such as cross members or reinforced-concrete walls). Align the antennas upwards in a V-shape.

... for multi-channel operation

- Each of the frequency banks “1” to “20” accommodates factory-preset receiving frequencies which are intermodulation-free. For possible frequency combinations, please refer to the supplied frequency information sheet.
- The channels in the frequency banks “U1” to “U6” can be assigned freely selectable frequencies (see page 39).
- When using several transmitters simultaneously, interference can be avoided by maintaining a minimum distance of 20 cm between two transmitters.
- Use accessories recommended by Sennheiser for multi-channel applications (see page 53).

If a problem occurs ...

Problem	Possible cause	Possible solution
Receiver cannot be operated, "Locked" appears on the display panel	Lock mode is activated	Deactivate the lock mode (see page 23).
No operation indication	No mains connection	Check the connections of the mains unit.
No RF signal	Transmitter and receiver are not on the same channel	Set the transmitter and receiver to the same channel. To do so, use the synchronization function (see page 22).
	Transmission range is exceeded	Check the squelch threshold setting (see page 39). Reduce the distance between transmitter and receiving antennas.
RF signal available, no audio signal, "MUTE" appears on the display panel	If "RX Mute" additionally appears on the display panel: receiver is muted	Cancel the muting on the receiver (see page 24).
	If "TX Mute" additionally appears on the display panel: transmitter is muted or doesn't transmit a pilot tone	Cancel the muting on the transmitter (see the instruction manual of the transmitter).
		Activate the pilot tone transmission on the transmitter (see the instruction manual of the transmitter).
	Deactivate the pilot tone evaluation on the receiver (see page 42).	
Receiver's squelch threshold is adjusted too high	Reduce the squelch threshold (see page 34).	
	Reposition the antennas.	
Audio signal has a high level of background noise	Transmitter sensitivity is adjusted too low	Adjust the transmitter sensitivity correctly (see the instruction manual of the transmitter).

If a problem occurs ...

Problem	Possible cause	Possible solution
Audio signal is distorted	Transmitter sensitivity is adjusted too high	Adjust the transmitter sensitivity correctly (see the instruction manual of the transmitter).
	Receiver's audio output level is adjusted too high	Reduce the audio output level (see page 37).
No access to a certain channel	During scanning, an RF signal has been detected on this channel and the channel has been locked	Set the transmitter operating on this channel to a different channel and redo the frequency preset scan (see page 35).
	During scanning, a transmitter of your system operating on this channel has not been switched off	Switch the transmitter off and redo the frequency preset scan (see page 35).
During the sound-check, only one diversity display (I or II) appears on the display panel	One of the antennas is not correctly connected	Check the antenna cable or the antenna.
	Antennas are not optimally positioned	Reposition the antennas.
None of the diversity displays I or II appears on the display panel	Receiver's squelch threshold is adjusted too high	Reduce the squelch threshold (see page 34).
	Transmitter's RF signal is too weak	Increase the transmission power of the transmitter.
		Reduce the distance between transmitter and receiver.

If a problem occurs that is not listed in the above table or if the problem cannot be solved with the proposed solutions, please contact your local Sennheiser partner for assistance.

To find a Sennheiser partner in your country, search at www.sennheiser.com under "Service & Support".

Accessories and spare parts

The following accessories are available from your specialist dealer:

Cat. No.	Product name and description
503167	GA 3 rack adapter
009912	AM 2 antenna front mount kit (for GA 3 rack adapter)
503165	ASA 1 active antenna splitter, 2 x 1:4, for connecting four EM 500 G3 to two antennas/antenna boosters
503158	NT 1-1 EU Mains unit for powering the ASA 1 antenna splitter or the L 2015 charger, EU version
503873	NT 1-1 US Mains unit for powering the ASA 1 antenna splitter or the L 2015 charger, 120 V version
503874	NT 1-1 UK Mains unit for powering the ASA 1 antenna splitter or the L 2015 charger, UK version
503157	NT 2-3 EU Mains unit for powering the EM 500 G3 rack-mount receiver, EU version
503870	NT 2-3 US Mains unit for powering the EM 500 G3 rack-mount receiver, 120 V version
503871	NT 2-3 UK Mains unit for powering the EM 500 G3 rack-mount receiver, UK version

Antennas

004645 A 1031 antenna, broadband, omni-directional

003658 A 2003 antenna, broadband, directional

Antenna boosters for ASA 1

502567 AB 3-A: 516–558 MHz

502572 AB 3-G: 566–608 MHz

502568 AB 3-B: 626–668 MHz

502569 AB 3-C: 734–776 MHz

502570 AB 3-D: 780–822 MHz

502571 AB 3-E: 823–865 MHz

Antenna cables

002324 GZL 1019-A1 coaxial cable, type RG 58, BNC to BNC, 1 m

002325 GZL 1019-A5 coaxial cable, type RG 58, BNC to BNC, 5 m

002326 GZL 1019-A10 coaxial cable, type RG 58, BNC to BNC, 10 m

Specifications

RF characteristics

Modulation	wideband FM
Frequency ranges	516–558, 566–608, 626–668, 734–776, 780–822, 823–865 MHz (A–E, G, see page 5)
Receiving frequencies	1,680 receiving frequencies, tuneable in steps of 25 kHz
	20 frequency banks, each with up to 32 factory-preset channels, intermodulation-free
	6 frequency banks, each with up to 32 user programmable channels
Switching bandwidth	42 MHz
Nominal/peak deviation	± 24 kHz/ ± 48 kHz
Receiver principle	true diversity
Sensitivity (with HDX, peak deviation)	$< 2 \mu\text{V}$ for 52 dBA _{rms S/N}
Adjacent channel rejection	typ. ≥ 75 dB
Intermodulation attenuation	typ. ≥ 70 dB
Blocking	≥ 75 dB
Squelch	Off, 5 to 25 dB μV , adjustable in steps of 2 dB
Pilot tone squelch	can be switched off
Antenna inputs	2 BNC sockets

AF characteristics

Compander system	Sennheiser HDX
EQ presets	
Preset 1: "Flat"	
Preset 2: "Low Cut"	-3 dB at 180 Hz
Preset 3: "Low Cut/High boost"	-3 dB at 180 Hz +6 dB at 10 kHz
Preset 4: "High Boost"	+6 dB at 10 kHz
S/N ratio (1 mV, peak deviation)	≥ 115 dBA

Specifications



THD	≤ 0.9%
AF output voltage (at peak deviation, 1 kHz AF)	¼" (6.3 mm) jack socket (unbalanced): +12 dBu XLR socket (balanced): +18 dBu
Adjustment range of audio output level	48 dB, adjustable in steps of 3 dB +6 dB gain reserve

Overall device

Temperature range	-10°C to +55°C
Power supply	12 V ===
Current consumption	350 mA
Dimensions	approx. 202 mm x 212 mm x 43 mm
Weight	approx. 980 g

Type approvals

In compliance with

Europe	 EMC EN 301489-1/-9 Radio EN 300422-1/-2 Safety EN 60065
USA	 47 CFR 15 subpart B

Approved by

Canada	Industry Canada RSS 123 IC: 2099A-G3SKMEM
--------	--

NT 2-3 mains unit



Input voltage	100 to 240 V~, 50/60 Hz
Current consumption	max. 120 mA
Output voltage	12 V ===
Secondary output current	400 mA
Energy efficiency level	IV
Temperature range	10°C to +40°C

In compliance with (NT 2-3)

Europe	 EMC EN 55022, EN 55024, EN 55014-1/-2 Safety EN 60065
USA	 47 CFR 15 subpart B
Canada	ICES 003

The mains unit is certified in accordance with the legal safety requirements of Europe, the United States, Canada, Russia and Japan.

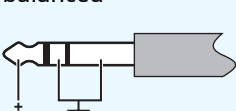
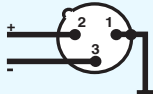
Connector assignment

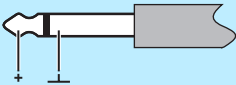
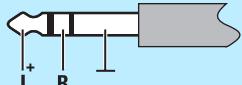
Audio		Other connectors
1/4" (6.3 mm) stereo jack plug, balanced 	XLR-3F connector, balanced 	DC connector for power supply 
1/4" (6.3 mm) mono jack plug, unbalanced 	1/4" (6.3 mm) stereo jack plug for headphone output 	

Manufacturer Declarations

Warranty

Sennheiser electronic GmbH & Co. KG gives a warranty of 24 months on this product.

For the current warranty conditions, please visit our website at www.sennheiser.com or contact your Sennheiser partner.

In compliance with the following requirements

- RoHS Directive (2002/95/EC)
- WEEE Directive (2002/96/EC)



Please dispose of the receiver at the end of its operational life-time by taking it to your local collection point or recycling center for such equipment.

CE Declaration of Conformity

- **CE 0682**
- R&TTE Directive (1999/5/EC), EMC Directive (2004/108/EC), Low Voltage Directive (2006/95/EC)

The declarations are available at www.sennheiser.com.

Before putting the device into operation, please observe the respective country-specific regulations.

Statements regarding FCC and Industry Canada

This device complies with Part 15 of the FCC Rules and with RSS-210 of Industry Canada. Operation is subject to the following two conditions: (1) this device may not cause harmful interference, and (2) this device must accept any interference received, including interference that may cause undesired operation.

This equipment has been tested and found to comply with the limits for a Class B digital device, pursuant to Part 15 of the FCC Rules. These limits are designed to provide reasonable protection against harmful interference in a residential installation. This equipment generates, uses and can radiate radio frequency energy and, if not installed and used in accordance with the instructions, may cause harmful interference to radio communications. However, there is no guarantee that interference will not occur in a particular installation. If this equipment does cause harmful interference to radio or television reception, which can be determined by turning the equipment off and on, the user is encouraged to try to correct the interference by one or more of the following measures:

- Reorient or relocate the receiving antenna.
- Increase the separation between the equipment and receiver.
- Connect the equipment into an outlet on a circuit different from that to which the receiver is connected.
- Consult the dealer or an experienced radio/TV technician for help.

This class B digital device complies with the Canadian ICES-003.

Changes or modifications made to this equipment not expressly approved by Sennheiser electronic Corp. may void the FCC authorization to operate this equipment.

Before putting the device into operation, please observe the respective country-specific regulations!

Index

Activating/deactivating

- lock mode (Auto Lock) 38
- pilot tone evaluation 42
- warnings (Warnings) 43

Adjusting

- audio output level (AF Out) 37
- contrast (LCD Contrast) 43
- network configuration 44
- squelch threshold (Squelch) 34
- transmitter parameters (Sync Settings) 41

Advanced Menu (extended menu)

- overview 28
- settings 39

AF Out (adjusting the audio output level) 37

AF PEAK (warning message) 43

Amplifier/mixing console, connecting 17

Antennas, mounting 13

Audio signal

- monitoring via headphones 21
- muting (Mute) 24

Auto Lock (activating/deactivating the lock mode) 38

Buttons (function of the ~) 26

Channel

- overview 6
- selecting (Easy Setup) 35, 45
- selecting (Frequency Preset) 36
- selecting (Tune) 39

Cleaning (receiver) 49

Connecting

- amplifier/mixing console 17
- headphones 21
- mains unit 19

Current List (selecting an unused frequency preset) 35

Deactivating (lock mode temporarily) 23

Displays

- adjusting the contrast (LCD Contrast) 43
- overview 10
- standard displays 25

Easy Setup (submenu)

- overview 28
- settings 35

Equalizer (modifying the frequency response) 38

Frequency

- preset frequencies 6
- ~ ranges 6
- selecting (Frequency Preset) 36
- selecting ~ presets 36
- setting a Receiving frequency 39

Frequency bank

- overview 6
- ~ system 6
- selecting (Easy Setup) 35, 45
- selecting (Frequency Preset) 36
- selecting (Tune) 39

Frequency Preset (selecting a frequency bank/channel) 36

Frequency presets

- releasing (Reset List) 35
- searching for unused ~ (Scan New List) 35, 45
- selecting (Current List) 35

Guitar Tuner

- changing the settings 40

guitar Tuner

- tuning a guitar 31

Headphones, connecting 21

Infra-red transmission 22

IP-Address (adjusting the network configuration) 44

- LCD Contrast (contrast of the display panel) 43
- Lock mode
 - activating/deactivating (Auto Lock) 38
 - deactivating temporarily 23
- Locked (lock mode activated) 23
- Low Battery (warning message) 43
- Low RF Signal (warning message) 43

- Mains unit, connecting 19
- Menu (main menu)
 - overview 27
 - settings 34
- Mixing console/amplifier, connecting 17
- Mounting
 - antennas 13
 - rack mount "ears" 12
 - receiver 12
- Multi-channel operation 46
- Mute (muting the audio signal) 24
- Muting (audio signal) 24

- Name (entering a name) 37
- Network (connecting receivers in a network) 18, 46
- Network configuration, adjusting 44

- Operating menu, using 29

- Pilot tone evaluation, activating/deactivating 42

- Rack mount "ears", Mounting 12
- Rack mounting
 - one receiver 14
 - two receivers 16
- Receiver
 - cleaning 49
 - connecting ~s in a network 18, 46
 - mounting into a rack 12
 - ~ parameters (standard display) 10
 - placing onto a flat surface 12
 - switching on/off 20
 - synchronizing with transmitter 22, 45
- Receiving Frequency
 - selecting (Frequency Preset) 39
- Receiving frequency
 - selecting (Frequency Preset) 35
 - setting (Tune) 39
- Reception, optimizing 50
- Reset List (releasing all locked frequency presets) 35
- RF (Radio Frequency) 10
- RF Mute (warning message) 43
- RX Mute (warning message) 43
- RX Mute On/Off (muting the audio signal) 24

- Scan New List (frequency preset scan) 35, 45
- Setting up
 - multi-channel system 46
 - transmission link 45
- Settings
 - equalizer 38
 - Guitar Tuner 40
- Software Revision (displaying the software revision) 44
- Squelch (adjusting the squelch) 34
- Switching on/off (receiver) 20
- Sync Settings (submenu)
 - overview 28
 - settings 41
- Synchronizing (transmitter with receiver) 22, 45

- Transmission link, setting up 45
- Transmitter
 - adjusting the transmitter parameters (Sync Settings) 41
 - synchronizing with receiver 22, 45
- Troubleshooting 51
- Tune (setting the receiving frequencies and frequency banks) 39
- TX Mute (warning message) 43

- Unlock (deactivating the lock mode) 23

Using

- Guitar Tuner 31
- operating menu 29
- receiver 20

Warnings (Warnings)

- activating/deactivating 43
- overview of warning messages 43

WSM (Wireless Systems Manager) 18, 46

Sennheiser electronic GmbH & Co. KG
Am Labor 1, 30900 Wedemark, Germany
www.sennheiser.com

Printed in Germany
Publ. 02/09
529665/A01