

Specifications

LS73D Series	55LS73D	49LS73D	42LS73D
Screen Size	55"	49"	42"
Panel Technology	IPS	IPS	IPS
Aspect Ratio	16:9	16:9	16:9
Native Resolution	1,920 x 1,080 (FHD)	1,920 x 1,080 (FHD)	1,920 x 1,080 (FHD)
Brightness	500cd/m ²	500cd/m ²	500cd/m ²
Contrast Ratio	1,300:1	1,300:1	1,300:1
Viewing Angle (H x V)	178 x 178	178 x 178	178 x 178
Response Time	8ms (G to G BW) typ.	8ms (G to G BW) typ.	8ms (G to G BW) typ.
Surface Treatment	Hard Coating (3H), Anti-glare treatment of the front polarizer (Haze 10%)	Hard Coating (3H), Anti-glare treatment of the front polarizer (Haze 10%)	Hard Coating (3H), Anti-glare treatment of the front polarizer (Haze 10%)
Guaranteed Operation Hours	24 Hrs	24 Hrs	24 Hrs
Orientation	Portrait & Landscape	Portrait & Landscape	Portrait & Landscape
Input	HDMI (2), DP, DVI-D, Audio In, OPS, USB 3.0		
Output	DP, External Speaker Out		
External Control	RS232C In/out, RJ45 In, IR/Light Sensor In, Pixel Sensor In		
Bezel Color	Black	Black	Black
Bezel Width	7.4 mm (T/L/R/B Even)	7.4 mm (T/L/R/B Even)	7.4 mm (T/L/R/B Even)
Monitor Dimension (W x H x D)	1,230 x 714 x 32 mm	1,095 x 637 x 32 mm	949 x 555 x 32 mm
Weight (Head)	20.7 kg	15.6 kg	12.5kg
Monitor with Optional Stand Dimensions (W x H x D)	1,230 x 776 x 298 mm	1,095 x 700 x 298 mm	949 x 618 x 298 mm
Weight (Head+Stand)	22.1 kg	17.0 kg	13.9 kg
Carton Dimensions (W x H x D)	1,330 x 815 x 174 mm	1,197 x 760 x 134 mm	1,045 x 645 x 127 mm
Packed Weight	25.2 kg	18.7 kg	14.8 kg
VESA™ Standard Mount Interface	400 x 400 mm	400 x 400 mm	400 x 400 mm
SPECIAL FEATURES	Temperature Sensor, Auto Brightness Sensor, Tile Mode(up to 15x15), Wake on LAN, DPM Select, DPM Wake Up, Energy Saving, Smart Energy Saving, File Play with USB, PIP/PBP(2), Internal Memory 16GB (System 4GB + Available 12GB), Wi-Fi Dongle Ready (802.11n), USB Cloning, Fail Over		
ENVIRONMENTAL CONDITIONS	Operating Temperature: 0°C to 40°C	Operating Temperature: 0°C to 40°C	Operating Temperature: 0°C to 40°C
	Operating Humidity: 10% to 80%	Operating Humidity: 10% to 80%	Operating Humidity: 10% to 80%
POWER	Power Supply: 100-240V~, 50/60Hz	Power Supply: 100-240V~, 50/60Hz	Power Supply: 100-240V~, 50/60Hz
	Power Type: Built-In Power	Power Type: Built-In Power	Power Type: Built-In Power
	Power Typ.: 120 W	Power Typ.: 105 W	Power Typ.: 80 W
	Consumption Smart Energy Saving: 85 W	Consumption Smart Energy Saving: 75 W	Consumption Smart Energy Saving: 60 W
STANDARD (CERTIFICATION)	Safety: UL / cUL / CB / TUV / KC	Safety: UL / cUL / CB / TUV / KC	Safety: UL / cUL / CB / TUV / KC
	EMC: FCC Class "A" / CE / KCC	EMC: FCC Class "A" / CE / KCC	EMC: FCC Class "A" / CE / KCC
	ErP / Energy Star: NA / Yes (Energy Star 7.0)	ErP / Energy Star: NA / Yes (Energy Star 7.0)	ErP / Energy Star: NA / Yes (Energy Star 7.0)
MEDIA PLAYER COMPATIBILITY	OPS Type Compatible: Yes	OPS Type Compatible: Yes	OPS Type Compatible: Yes
	External Media Player Attachable: Yes (MP500 / MP700)	External Media Player Attachable: Yes (MP500 / MP700)	External Media Player Attachable: Yes (MP500 / MP700)
SOFTWARE COMPATIBILITY	Content Management Software: SuperSign Premium	Content Management Software: SuperSign Premium	Content Management Software: SuperSign Premium
	Control and Monitoring Software: SuperSign C	Control and Monitoring Software: SuperSign C	Control and Monitoring Software: SuperSign C
ACCESSORIES	Basic: Remote Controller (2ea batteries included), Power Cord, IR / Light Sensor Receiver, QSG, Regular Book, HDMI Cable	Basic: Remote Controller (2ea batteries included), Power Cord, IR / Light Sensor Receiver, QSG, Regular Book, HDMI Cable	Basic: Remote Controller (2ea batteries included), Power Cord, IR / Light Sensor Receiver, QSG, Regular Book, HDMI Cable
	Optional: External Speaker (SP-2100), ST-200T, LSW440S, Wi-Fi USB Dongle (AN-WF500), OPS Kits (KT-OPSA), Pixel Sensor (KT-SP0)	Optional: External Speaker (SP-2100), ST-200T, LSW440S, Wi-Fi USB Dongle (AN-WF500), OPS Kits (KT-OPSA), Pixel Sensor (KT-SP0)	Optional: External Speaker (SP-2100), ST-200T, LSW440S, Wi-Fi USB Dongle (AN-WF500), OPS Kits (KT-OPSA), Pixel Sensor (KT-SP0)

Connectivity

- 1 SPEAKER OUT
- 2 AUDIO IN
- 3 LAN
- 4 PIXEL SENSOR
- 5 HDMI
- 6 IR & LIGHT SENSOR
- 7 DP IN
- 8 DP OUT
- 9 DVI-D IN
- 10 USB 3.0
- 11 RS232C IN
- 12 RS232C OUT

55LS73D, 49LS73D, 42LS73D

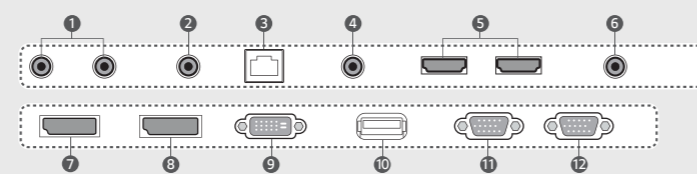

Download LG Commercial Display Mobile App



Learn more www.lg.com/b2b

YouTube youtube.com/c/LGCommercialDisplay

LG may make changes to specifications and product descriptions without notice. Copyright © 2017 LG Electronics Inc. All rights reserved. "LG Life's Good" is a registered trademark of LG Corp. The names of products and brands mentioned here may be the trademarks of their respective owners.



Smart Platform with a Powerful Embedded System-on-Chip Standard Premium LS73D Series

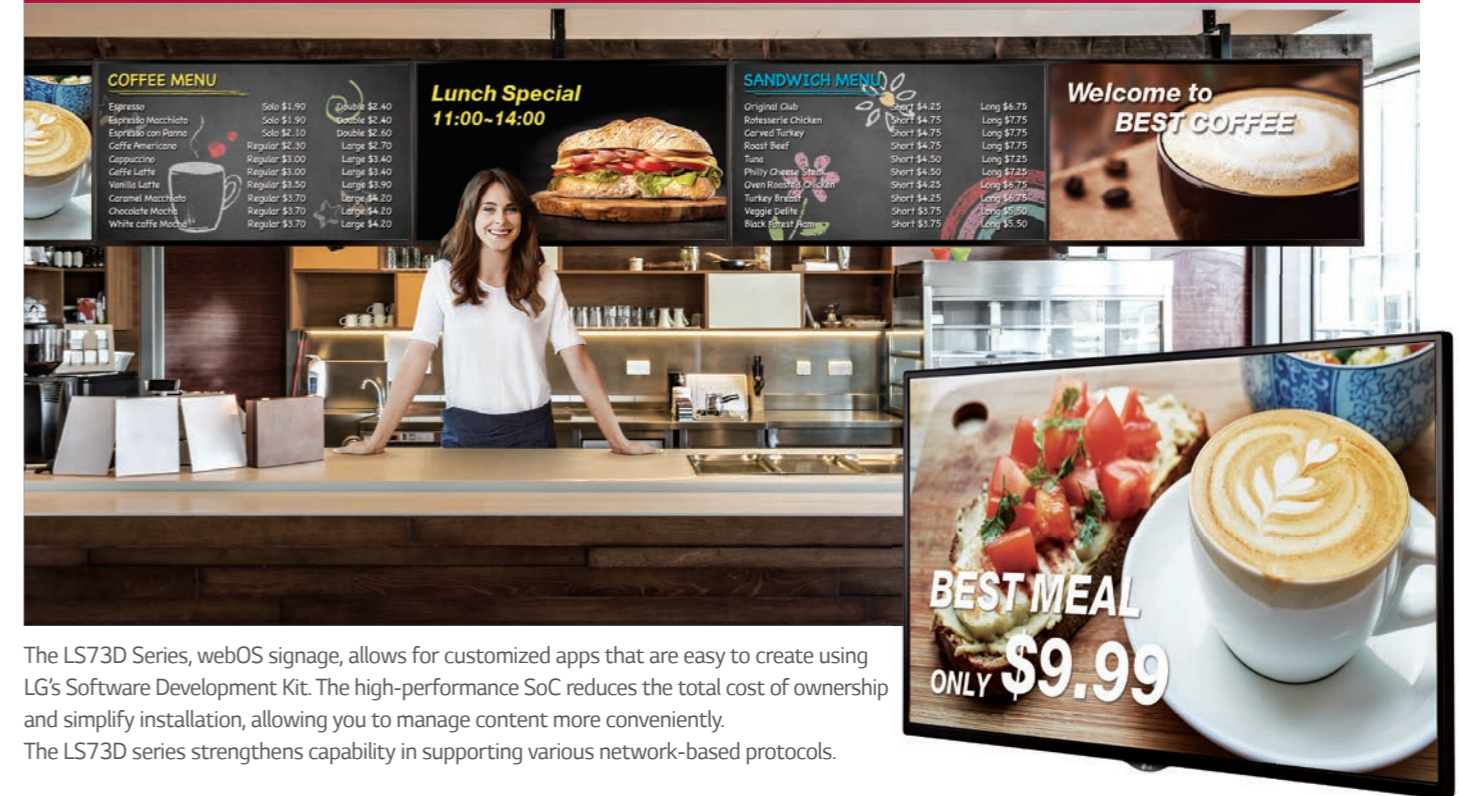

The LS73D Series, webOS signage, allows for customized apps that are easy to create using LG's Software Development Kit. The high-performance SoC reduces the total cost of ownership and simplify installation, allowing you to manage content more conveniently. The LS73D series strengthens capability in supporting various network-based protocols.

Key Features

Smart Platform



Quad Core SoC*

The high-performance SoC can execute several tasks at the same time and provides smooth content playback.



*System-on-Chip

webOS 3.0

The webOS 3.0 platform provides powerful and convenient creation tools, including app development materials.



Group Manager

Content can be created, distributed and controlled by a signage without a dedicated PC or server.

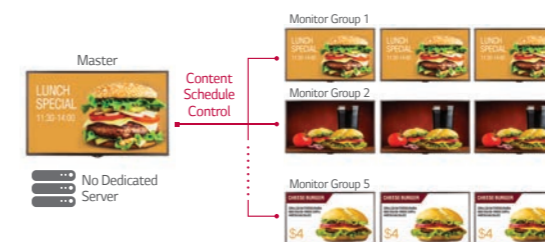

PBP (Picture-By-Picture) / PIP (Picture-In-Picture)

PBP (Picture-By-Picture) and PIP (Picture-In-Picture) features enable you to compose various layouts for several digital devices.



Smart Platform with a Powerful Embedded System-on-Chip

Standard Premium LS73D Series

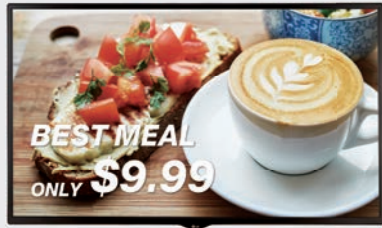

Screen Sizes

55", 49", 42"

LS73D Series

- Brightness: 500 cd/m²
- Bezel: 7.4 mm Even Bezel
- Depth: 32 mm
- Interface: HDMI (2), DVI-D, DP, RJ45, IR / Light sensor, RS232C, Pixel Sensor, USB 3.0, Audio



Key Features

Support Network Protocol

IP Streaming Protocol

Various types of IP video streaming protocol are supported, such as RTSP/RTP, MMS, HLS and MPEG-2 TS*.

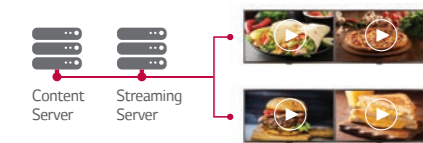

*RTSP (Real-Time Streaming Protocol), RTP (Real-time Transport Protocol), MMS (Microsoft Media Server), HLS (http live streaming)

Secure Communication Protocol

By supporting HTTPS* protocol, communication between server and signage is more secure.



*HTTPS: Hypertext Transfer Protocol over Secure Socket Layer

Proxy Server

Web access speed and security can be improved by supporting Proxy Server (A server that acts as an intermediary for requests from clients seeking resources from other servers.)



Wireless Solution

Mirroring

Content sharing is more convenient on a Wi-Fi network.



SoftAP

The LS73D with SoftAP software can operate as a wireless access point for mobile devices.



Simple Installation

Installation has been simplified by removing the external media player and Ethernet/RS232C cables.

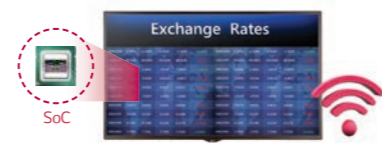

Wi-Fi (removing Ethernet or RS232C cables) 802.11n (2.4 GHz / 5 GHz)

Supportive Convenience

BEACON

With BEACON and Bluetooth Low Energy (BLE) supported by LS73D*, retail stores can provide coupons and information in real time. When Wi-Fi dongle is connected, the BEACON is available.



* LS73D is enhanced to support iBeacon** and Eddystone***
** iBeacon: Bluetooth Low Energy beacon profile released by Apple in 2013
*** Eddystone: Bluetooth Low Energy beacon profile released by Google in 2015

Industrial Design

Slimmer Even Bezel & Depth

The thinner bezel & depth allows a perfect fit for a sleek look.

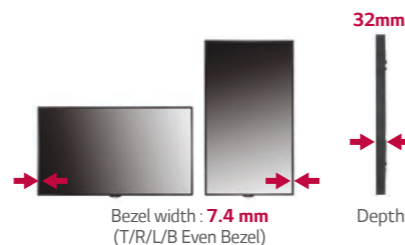

Detachable Logo

Portrait mode allows the logo to be positioned in the desired setting.



Dimensions (unit: mm)

55"

1,230 x 714 x 32 / 20.7 kg

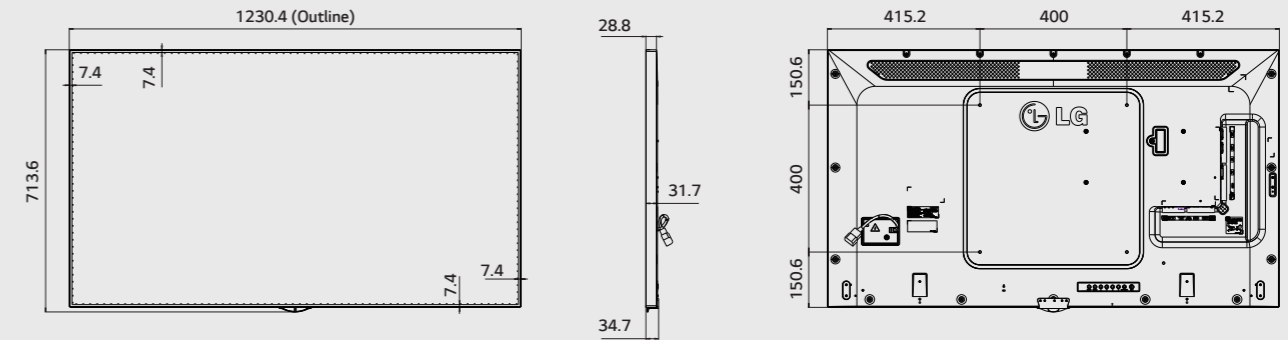

49"

1,095 x 637 x 32 / 15.6 kg

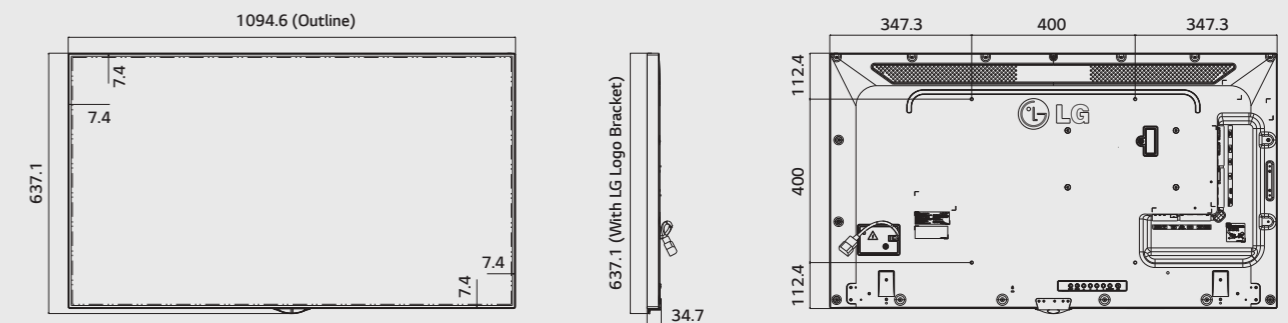

42"

949 x 555 x 32 / 12.5 kg

